

# COSCO®

SIMPLE

SMART

FUN



**Send Us a Text:** 1-812-652-2525  
(US and Canada Only. Carrier Fees May Apply)



**Find Us Online:** [www.coscokids.com](http://www.coscokids.com)

**Email Us:** [support@djgusa.com](mailto:support@djgusa.com)



**Give Us a Call:** 1-800-544-1108  
(Toll Free, US and Canada Only)

## Replacement Parts List

(on select models)

- Buckle Assembly
- Chest Clip
- Seat Pad Set
- Removable Cup Holder(s)
- Harness Strap
- Lower Anchor Belt
- Top Tether
- Locking Clip
- Instructions

**For parts availability and questions, call, text, or chat.**

**If requested color is not available, similar color  
will be substituted.**

**Applicable tax and shipping & handling will also be added.**

®  
COSCO

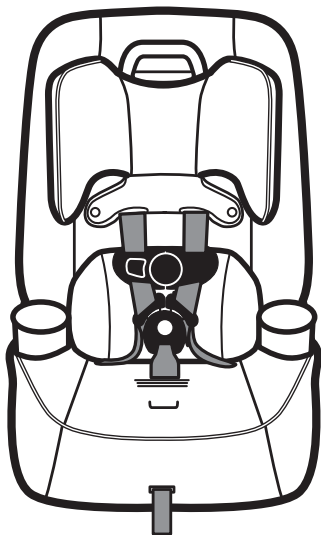

4358-8315  
2.3.23



## EASY ELITE SLIM

### ALL-IN-ONE CAR SEAT

KEEP INSTRUCTIONS FOR FUTURE USE.

Read all instructions before using this car seat.

**⚠️ WARNING:** Failure to follow the warnings on the labels and in the instruction manual can result in serious injury or death to your child.

## Welcome to the Cosco Family!

Thank you for choosing this car seat, also known as a child restraint!

To help you get started using your child's new car seat, here are the 4 main tasks you'll need to complete.

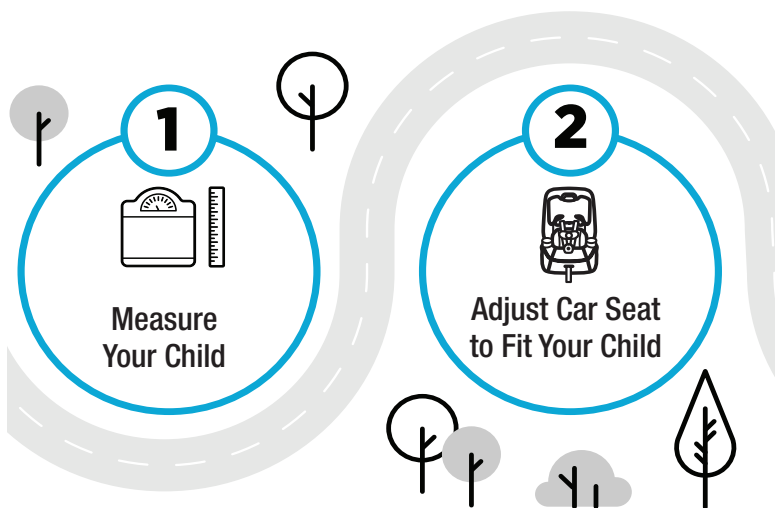

**Your child's safety is worth the time it will take to read and follow these instructions.**

**Ready? Let's go!**

**Pages 1-3** will introduce you to the parts of the car seat.

**The Back Cover of this Manual** has our contact information. If at any point you would like assistance, please feel free to reach out to us.

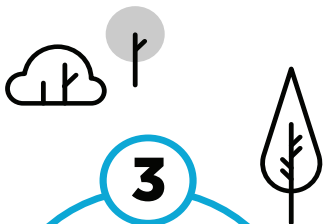

**Install Car Seat  
into Your Vehicle**



**Secure Your Child  
in Car Seat**

©2023 Dorel Juvenile Group, Inc. (800) 544-1108 [www.coscokids.com](http://www.coscokids.com). Styles and colors may vary. Les styles et les couleurs peuvent varier. Los estilos y los colores pueden variar. Made in USA from American and imported parts (including seat pad). Hecho en EE.UU. a partir de piezas americanas e importadas (incluyendo la almohadilla del asiento). Distributed by (distribuido por) Dorel Juvenile Group, Inc., 2525 State St., Columbus, IN 47201-7494. Dorel Juvenile Canada, 2233 Argentia Road, Suite 110, Mississauga, ON L5N 2X7. Importado y Distribuido en Chile por: Comercial e Industrial Silfa S.A. - San Ignacio 0201 / Parque Industrial Portezuelo Quilicura, Santiago Chile. Fono (562) 2339 9000. En Perú por: Comexa S.A. - Los Libertadores 455 - San Isidro, Lima - Perú. Fono (511) 4469014. En Centro América, Caribe y Ecuador por: Best Brands Group S.A. - Av. Balboa, Bay Mall Plaza, Planta Baja, local 9, Panamá. - Fono: (507) 300 2884. En Colombia por: Baby Universe S.A.S. Vía 40 No. 77-29, Barranquilla, Colombia - Fono: (575) 353 1110 Importador: DJGM, S.A. DE C.V. Gabriel Mancera No. 1041 Col. Del Valle, Benito Juárez C.P. 03100 México, Ciudad de México R.F.C. DJG140305GN9 Tel. (55) 67199202

**DOREL**

# Contents

## 1 Getting Started

---

- 1 Parts of Car Seat
- 3 Accessory Use
- 4 Choosing Car Seat Mode

## 6 Rear-Facing Section

---

- 8 Rear-Facing Child Fit
- 10 Rear-Facing Vehicle Install

## 16 Forward-Facing Section

---

- 18 Forward-Facing Child Fit
- 20 Forward-Facing Vehicle Install

## 27 Securing Child in Car Seat

---

## 30 Booster Seat Section

---

- 32 Storing Harness System
- 35 Booster Seat Use in Vehicle
- 38 Booster Seat Child Fit

## 39 Making Adjustments to Car Seat

---

- 39 Changing Headrest/Harness Height
- 40 Changing Buckle Position
- 42 Buckle Adjustments  
for Smaller Infants
- 44 Reclining Car Seat

## **45 Wash & Care**

---

- 45 Removing Seat Pad Set**
- 47 Cleaning Parts of Car Seat & Installing Seat Pad Set**
- 48 Installing Harness System**

## **53 LATCH & Vehicle Belt Information**

---

- 53 LATCH: Lower Anchor Belt**
- 55 Vehicle Belts**
- 59 Top Tether**

## **60 Safety Information**

---

- 60 Child Restraint Use**
- 61 Vehicle Seating Position**
- 62 Installation in Vehicle**
- 63 Replacement & Expiration**
- 64 Registration & Safety Notices**
- 65 Aircraft Information**

## **66 Warranty**

---

# 1

## Parts of Car Seat

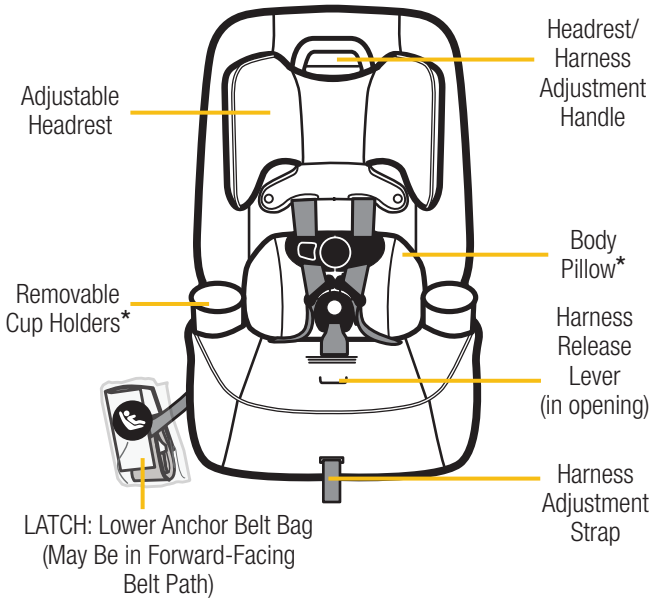

### Harness System Detail

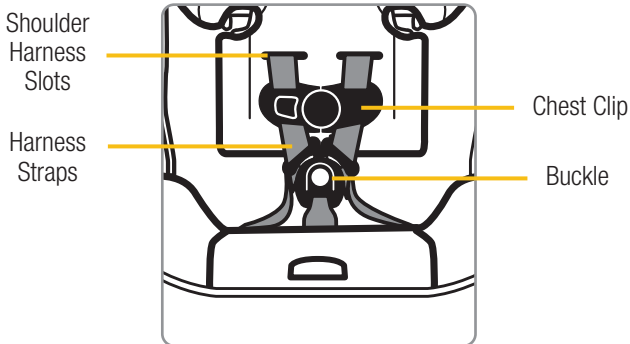

\*See page 3 for Accessory Use.

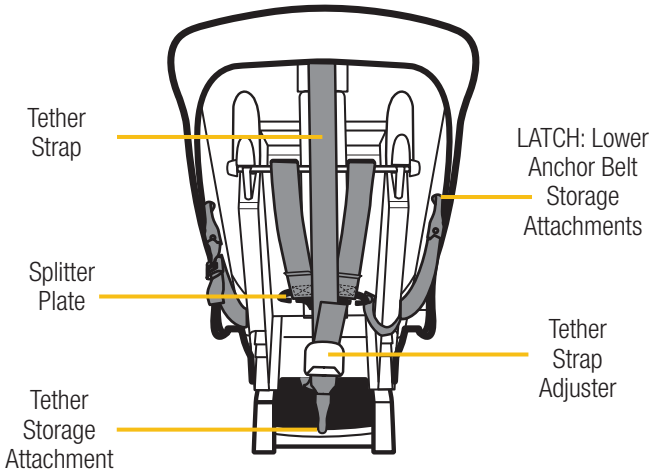
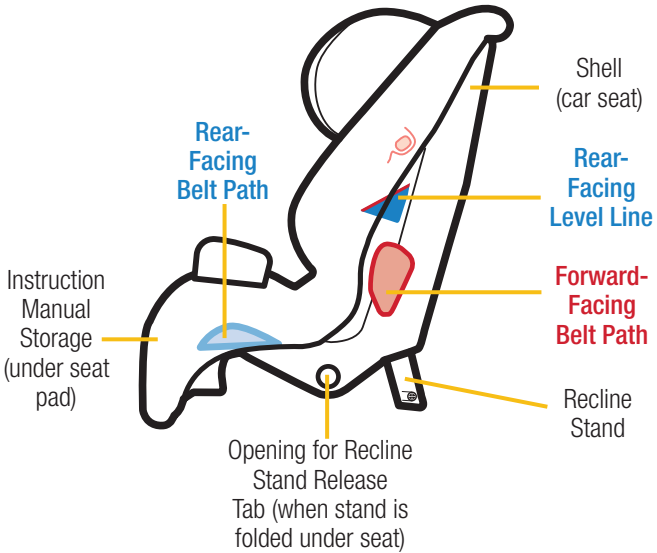

# 3

## Accessory Use

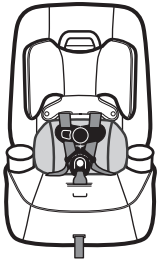

**Body Pillow**  
(on select models)

**For Use in Rear-Facing Mode Only**

**To remove**, slide it out from behind the harness straps.

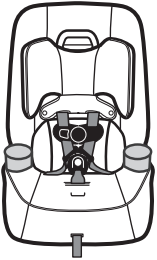

**Removable Cup Holder(s)**  
(on select models)

**For Use in All Modes**

**The cup holder(s) is top-rack dishwasher safe.**

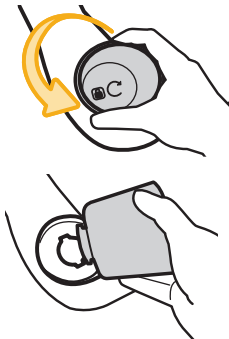

**To remove cup holder**, twist the cup holder counterclockwise. Pull it out of the slot in the car seat.

### **WARNING:**

Measure your child's weight and height **(DO NOT guess)** before choosing this car seat's mode.

Your child's height, weight, and age determine how the car seat should be placed in the vehicle.

Children vary widely in body size, shape, and temperament—**please consult your doctor before switching between any modes within the limits and fit requirements of the car seat.**

### **State Laws**

Please be certain to follow your state's laws regarding car seat use.

### **American Academy of Pediatrics Recommendations**

#### **Infants and Toddlers**

Should ride in a rear-facing car seat as long as possible, until they reach the highest weight or height allowed by their car seat.

#### **Toddlers and Preschoolers**

Once they are facing forward, children should use a forward-facing car seat with a harness for as long as possible, until they reach the height and weight limits for their car seats.

#### **School-Aged Children**

Once they have outgrown their forward-facing car seat, children should use a belt-positioning booster seat until the vehicle's lap and shoulder seat belt fits properly. This is often when they have reached at least 4 feet 9 inches in height and are 8 to 12 years old.

#### **Older Children**

All children younger than 13 years should be restrained in the rear seats of vehicles for optimal protection.



## Rear-Facing Mode

**5-40 lb (2.3-18 kg) and  
19-40 in. (48-101.6 cm)**

**Rear-Facing Section**

**PAGE 6**

**Rear-Facing Child Fit**

**PAGE 8**

**Rear-Facing Vehicle Install**

**PAGE 10**



## Forward-Facing Mode

**22-65 lb (10.1-29 kg) and  
29-49 in. (73.6-125 cm) and  
at least 1 year old**

**Forward-Facing Section**

**PAGE 16**

**Forward-Facing Child Fit**

**PAGE 18**

**Forward-Facing Vehicle Install PAGE 20**



## Booster Seat Mode

**40-100 lb (18.1-45.4 kg) and  
43-52 in. (110.1-132.1 cm)**

**Booster Seat Section**

**PAGE 30**

**Storing Harness System**

**PAGE 32**

**Booster Seat Use in Vehicle**

**PAGE 35**

**Booster Seat Child Fit**

**PAGE 38**

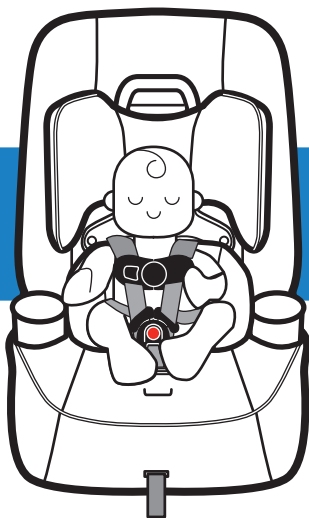

**5-40 lb (2.3-18 kg) and  
19-40 in. (48-101.6 cm)**

Children under 1 year of age **MUST** ride **Rear-Facing**.

In this car seat, your child can remain **Rear-Facing** until they outgrow any one of the following:

- **Weight Limit:** 40 lb (18 kg); **OR**
- **Height Limit:** 40 in. (101.6 cm); **OR**
- **Rear-Facing Child Fit** requirements, see pages 8-9.

Before installing the car seat in your vehicle, check your child's fit in the car seat.

This way you won't have to redo the vehicle installation to make adjustments to the car seat.

**Rear-Facing Child Fit: Page 8**

**Rear-Facing Vehicle Install: Page 10**

*continued on next page*



## WARNING:



**NEVER** install a rear-facing child restraint in the front seat of a vehicle equipped with an active frontal airbag.

**DO NOT** use the tether for rear-facing mode. Secure the tether strap hook to its storage attachment.

**DO NOT** use the lower anchor belt along with the vehicle lap or lap/shoulder belt.

**DO NOT** fasten multiple lower anchor hooks on the same lower anchor bar in the vehicle.

Check the vehicle belt or the lower anchor belt before each use. Use **ONLY** if the belt can be tightened properly and locked securely in place.

Even when unoccupied, this child restraint **MUST** be firmly secured to the vehicle with the lower anchor belt or with the vehicle seat belt.

This child restraint **MUST ALWAYS** face the rear of the vehicle until the child is at least 1 year old and weighs 22 lb (10 kg).

1

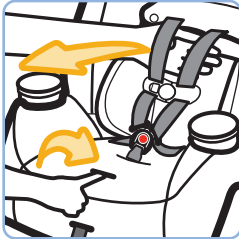

## Fully Loosen Harness Straps

Push down on the harness release lever (through the opening in the pad) while pulling out on the harness straps as shown.

2

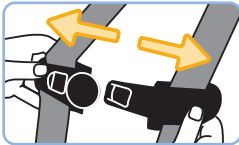

## Undo Chest Clip & Buckle

It may be easier to undo the buckle by pressing in towards the top of the button.

3

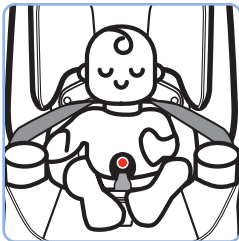

## Place Child in Car Seat

On select models: You may use the In and Out Harness Holders to place the harness straps out of the way.

Your child's bottom and back should be flat against the car seat.

4

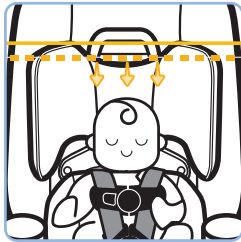

### Check Head Position

The top of your child's head **MUST be at least 1 in. (2.5 cm) below** the top of the car seat's headrest.

5

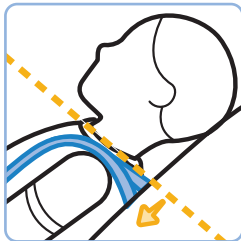

### Check Harness Strap Position

The harness strap **MUST be at or slightly below** the shoulders; never above.

6

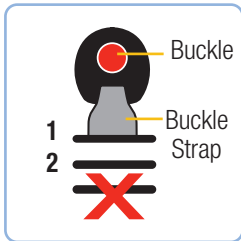

### Check Buckle Position

- Use the slot closest to your child.
- The buckle **should not be underneath or behind** your child.

**DO NOT** use the 3rd buckle slot in **Rear-Facing Mode**.



To change the harness strap height, see page 39.

To change the buckle position, see page 40.

To learn how to check harness tightness, see pages 27-29.

If you cannot achieve a snug harness fit for your child, see pages 39-43.

## Rear-Facing Vehicle Install

10

There are 2 different methods for install.

**Use only one:**



**Vehicle Belt**

OR



**LATCH: Lower  
Anchor Belt**



**WARNING:**

**DO NOT** use both the LATCH: lower anchor belt and vehicle belt at the same time to install the car seat.

i

Before installing the car seat in your vehicle, check to see if you need to adjust the buckle position for your child.

**See pages 8-9 for child fit.**

Once the car seat is installed, you will not be able to adjust the buckle position.

### **Review Vehicle Owner's Manual**

Determine what kind of vehicle belts your car has and how to use them to lock a car seat in place **OR** where LATCH: lower anchor seating positions are located in your vehicle.

*continued on next page*

1

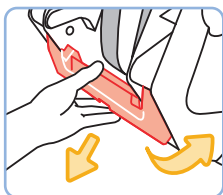

## Recline Car Seat

Pull down the recline stand to unlock and fold it under the car seat.

2

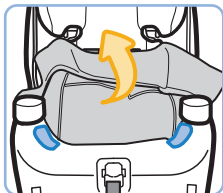

## Pull Seat Pad Off Front of Car Seat & Place Car Seat Rear-Facing in Back Seat

Be sure to place instruction manual back in storage area under front of pad.



3

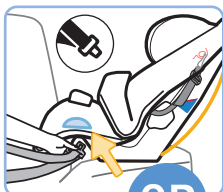

## Locate Rear-Facing Belt Path & Route Vehicle Belt or Lower Anchor Belt Through It

**For the LATCH belt:** You may need to fully lengthen the belt before routing it into the belt path. Squeeze the adjuster button and pull the belt out as shown.

OR



Pull the entire lower anchor belt over to the child's right as shown.

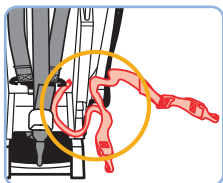

Then route the hook **on the adjuster end** through the **Rear-Facing Belt Path**.

4

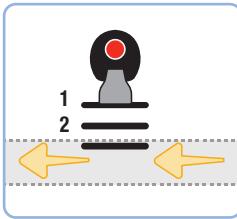

### Vehicle Belt or Lower Anchor Belt Goes:

- under the car seat pad; **AND**
- across the car seat; **AND**
- in front of the buckle; **AND**
- out the other **Rear-Facing Belt Path** opening.

**DO NOT** twist the belt.

i



Adjuster

### Finished Lower Anchor Belt Routing

The lower anchor belt adjuster **MUST** be on the child's left.

5

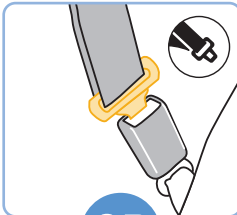

OR



### Buckle Vehicle Belt

If your car has a **switchable retractor**, use it to lock the vehicle belt. Review page 57 of this manual or your vehicle owner's manual.

### Attach Lower Anchor Belt Hooks to Vehicle's Lower Anchors

*continued on next page*

6

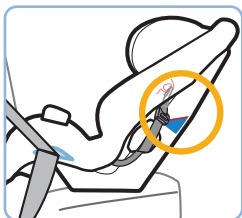

**Tuck Car Seat Pad Around Front of Car Seat & Check **Rear-Facing Level Line****

7

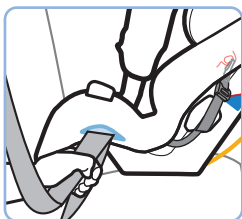

### **Tighten Belt**

Place your hand in the car seat and firmly push the car seat down and back towards the vehicle seat. Pull the belt towards you and parallel (in line) with the belt path as shown.

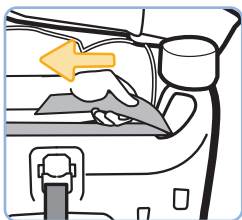

**For the LATCH belt or Lap Only Vehicle Belt:** it may be easier to tighten if you route the free end of the belt back into the **Rear-Facing Belt Path**, reach into the **Rear-Facing Belt Path**, and pull the free end of the belt towards you.

8

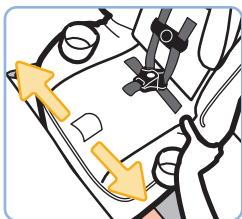

### **Check Belt Tightness**

Hold the **Rear-Facing Belt Path** with your non-dominant hand. Push and pull the car seat from side to side.

The car seat should not move more than **1 in.** (2.5 cm) at the belt path.



**If the car seat moves more than 1 in. (2.5 cm), you can try:**

- Pulling the belt tighter; **OR**
- Reinstalling the car seat; **OR**
- Changing to a different seating location; **OR**
- Switching to a different install method (LATCH or vehicle belt).

9

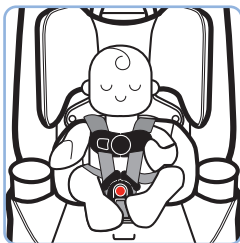

### Secure Child in Car Seat

See pages 27-29.

10

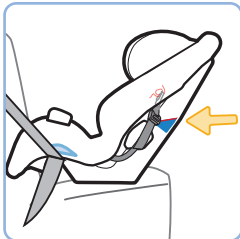

### Recheck Rear-Facing Level Line

Redo the installation if the car seat is not reclined correctly for your child.

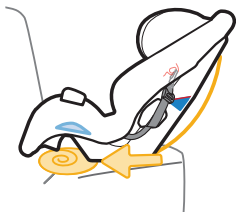

Only if necessary, you may place a tightly rolled towel(s) or foam pool noodle(s) under the front of the car seat to help make the **Rear-Facing Level Line** parallel with the ground.

Check often to make sure padding is still in place and the belt is tight.

## FINISHED!



**Lap/Shoulder  
Belt**



**Lap Belt**



**LATCH: Lower  
Anchor Belt**

- Vehicle Belt Install:** Is the vehicle belt locked? See step 5.
- LATCH: Lower Anchor Belt Install:** Are the hooks securely attached to the vehicle's lower anchors? See step 5.
- Is the belt tightened enough so that the car seat does not move more than 1 in. (2.5 cm) from side to side? Check the tightness of the install often to make sure it has not loosened. See steps 7 and 8.
- If your child cannot sit up unassisted, is the **Rear-Facing Level Line** parallel with the ground? See steps 6 and 10, and info boxes on page 14.



**22-65 lb (10.1-29 kg) and 29-49 in.  
(73.6-125 cm) and at least 1 year old**

Children **MUST** be at least 1 year of age to ride  
**Forward-Facing.**

In this car seat, your child can remain harnessed **Forward-Facing** until they outgrow any one of the following:

- **Weight Limit:** 65 lb (29 kg); **OR**
- **Height Limit:** 49 in. (125 cm); **OR**
- **Forward-Facing Child Fit** requirements, see pages 18-19.

Before installing the car seat in your vehicle, check your child's fit in the car seat.

This way you won't have to redo the vehicle installation to make adjustments to the car seat.

**Forward-Facing Child Fit: Page 18**

**Forward-Facing Vehicle Install: Page 20**

*continued on next page*



## WARNING:

**DO NOT** use the lower anchors of the child restraint anchorage system (LATCH system) to attach this child restraint when restraining a child weighing more than 55 lbs (24.9 kg).

The vehicle belt **MUST** be used for installation if your child weighs more than 55 lbs (24.9 kg).

When anchors are available you **MUST ALWAYS** attach, adjust, and secure the tether (top anchorage) strap when installing the car seat in the Forward-Facing Mode with internal harness.

**DO NOT** use the lower anchor belt along with the vehicle lap or lap/shoulder belt.

Check the vehicle belt or the lower anchor belt before each use.

Use **ONLY** if the belt can be tightened properly and locked securely in place.

**DO NOT** fasten multiple lower anchor hooks on the same lower anchor bar in the vehicle.

Even when unoccupied, this child restraint **MUST** be firmly secured to the vehicle with the lower anchor belt or with the vehicle seat belt.

In this child restraint your child **MUST** be at least 1 year old and weigh 22 lbs (10.1 kg) before they sit forward-facing.

1

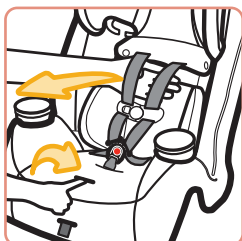

## Fully Loosen Harness Straps

Push down on the harness release lever (through the opening in the pad) while pulling out on the harness straps as shown.

2

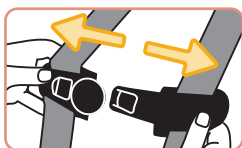

## Undo Chest Clip & Buckle

It may be easier to undo the buckle by pressing in towards the top of the button.



3

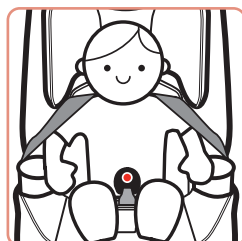

## Place Child in Car Seat

On select models: You may use the In and Out Harness Holders to place the harness straps out of the way.

Your child's bottom and back should be flat against the car seat.

4

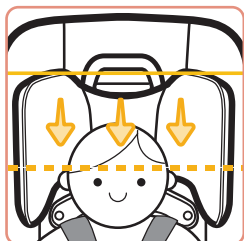

### Head Position

The tops of your child's ears **MUST be below** the top of the car seat's headrest.

5

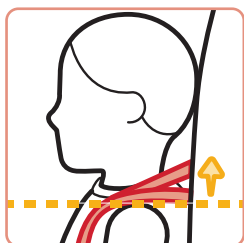

### Harness Strap Position

The harness strap **MUST be at or slightly above** the shoulders; never below.

6

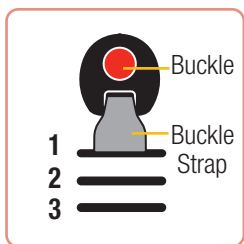

### Buckle Position

- Use the slot closest to your child.
- The buckle **should not be underneath or behind** your child.

The buckle can be used in **any** buckle slot.



To change the harness strap height, see page 39.

To change the buckle position, see page 40.

To learn how to check harness tightness, see pages 27-29.

If you cannot achieve a snug harness fit for your child, see pages 39-43.

## Forward-Facing Vehicle Install

20

There are 2 different methods for install.

**Use only one:**



### Vehicle Belt + Tether

for children up to  
65 lb (29 kg)



### LATCH: Lower Anchor Belt + Tether

Do not install by this method  
for children weighing more  
than 55 lb (24.9 kg).



## WARNING:

**DO NOT** use both the LATCH: lower anchor belt and vehicle belt at the same time to install the car seat.

When anchors are available, you **MUST ALWAYS** attach, adjust, and secure the tether (top anchorage) strap when installing the car seat in the Forward-Facing Mode with internal harness.



Before installing the car seat in your vehicle, check to see if you need to adjust the buckle position for your child. **See page 18 for child fit.**

Once the car seat is installed, you will not be able to adjust the buckle position.

### Review Vehicle Owner's Manual

Determine what kind of vehicle belts your car has and how to use them to lock a car seat in place **OR** where LATCH: lower anchor seating positions are located in your vehicle.

*continued on next page*

1

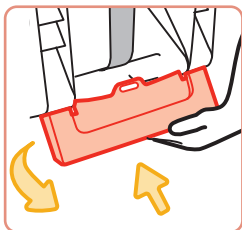

## Put Car Seat Upright into Position 1 & Place Car Seat Forward-Facing in Back Seat

The vehicle seat back **MUST** be upright.

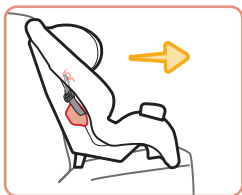

To make seat upright, on side of seat press in on round tab and rotate the recline stand down. Push it up to lock it into place as shown.

The recline stand and front of the car seat should be flat against the vehicle seat bottom.

i

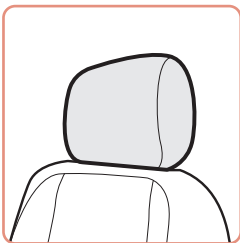

If your vehicle has a headrest that interferes with a flush car seat fit, check your vehicle owner's manual to see if it can be removed, adjusted, or if there are other possible seating locations for you to install.

2

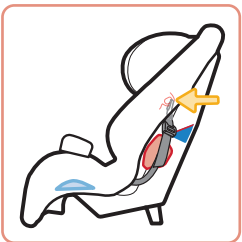

## Remove Lower Anchor Belt from Storage Location

Or if the lower anchor belt was used **Rear-Facing**, remove the belt from the **Rear-Facing Belt Path** so both hooks are on the same side of the car seat as shown.

3

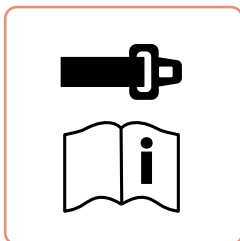

### Locate Vehicle Top Tether Anchors

Review your vehicle owner's manual for top tether anchor locations and how to route the tether strap when there are vehicle headrests.

4



### Loosely Attach Tether Hook to Vehicle's Top Tether Anchor

5



OR



### Locate **Forward-Facing Belt Path** & Route Vehicle Belt or Lower Anchor Belt Through It

**For the LATCH belt:** You may need to fully lengthen the belt before routing it into the belt path. Squeeze the adjuster button and pull the belt out as shown.

6

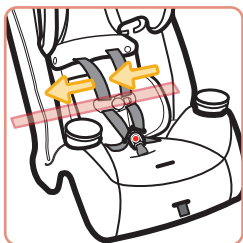

### Vehicle Belt or Lower Anchor Belt Goes:

- under the car seat pad; **AND**
- across the car seat; **AND**
- out the other **Forward-Facing Belt Path** opening.

**DO NOT** twist the belt.

i



### Finished Lower Anchor Belt Routing

The lower anchor belt adjuster can be on either side of the car seat.

7



### Buckle Vehicle Belt

If your car has a **switchable retractor**, use it to lock the vehicle belt. Review page 57 of this manual or your vehicle owner's manual.

OR



### Attach Lower Anchor Belt Hooks to Vehicle's Lower Anchors

8

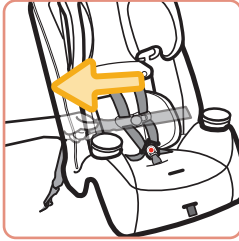
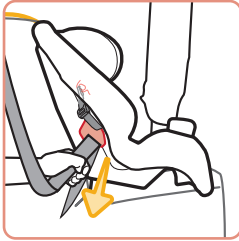

## Tighten Belt

Place your hand in the car seat and firmly push the car seat down and back towards the vehicle seat.

Pull the belt towards you and parallel (in line) with the belt path as shown.

**For the LATCH belt or Lap Only Vehicle Belt:** it may be easier to tighten if you route the free end of the belt back into the **Forward-Facing Belt Path**, reach into the **Forward-Facing Belt Path**, and pull the free end of the belt towards you.

9

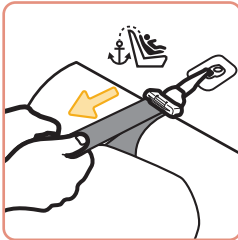

## Tighten Tether

Push firmly on the back of the car seat and pull the free end of the tether strap to remove all of the slack.

10

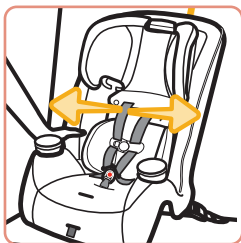

## Check Belt Tightness

Hold the **Forward-Facing Belt Path** with your non-dominant hand. Push and pull from side to side.

The car seat should not move more than **1 in.** (2.5 cm) at the belt path.



**If the car seat moves more than 1 in. (2.5 cm), you can try:**

- Pulling the belt tighter; **OR**
- Reinstalling the car seat; **OR**
- Changing to a different seating location; **OR**
- Switching to a different install method (LATCH or vehicle belt).

## FINISHED!

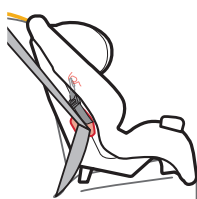

### Lap/Shoulder Belt + Tether

for children up to  
65 lb (29 kg)



### Lap Belt + Tether

for children up to  
65 lb (29 kg)



### LATCH: Lower Anchor Belt + Tether

Do not install by this method for children weighing more than 55 lb (24.9 kg).

- Vehicle Belt Install:** Is the vehicle belt locked? See step 7.
- LATCH: Lower Anchor Belt Install:** Are the hooks securely attached to the vehicle's lower anchors? See step 7.
- Is the belt tightened enough so the car seat does not move more than 1 in. (2.5 cm) from side to side? Check the tightness of the install often to make sure it has not loosened. See steps 8 and 10.
- Has the tether been installed and tightened? See steps 4 and 9.

## Securing Child in Car Seat

1

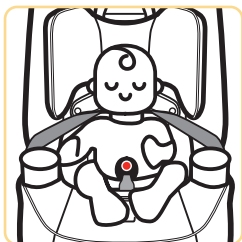

### Place Child in Car Seat

Your child's bottom and back should be flat against the car seat.

2

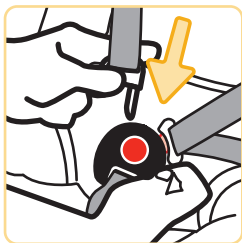

### Buckle Harness

Pull the harness straps up to make sure the buckle is locked.

3

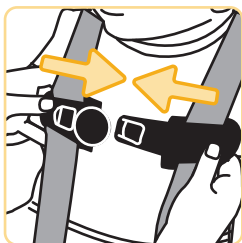

### Fasten Chest Clip

Insert right half of the chest clip into the left half and snap together.

4

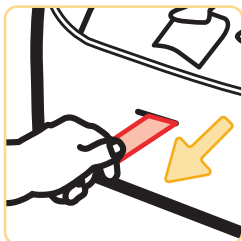

### Tighten Harness

Pull the harness adjustment strap straight out to snugly tighten the harness.

5

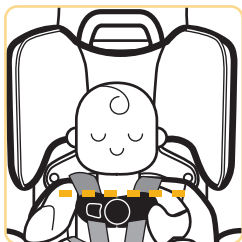

### Position Chest Clip

Slide the chest clip up the harness straps and position it at mid-chest (even with armpits) and away from your child's neck.

6



### Check Harness Tightness

Try to pinch the harness at the shoulders vertically between index finger and thumb as shown.

**If your fingers slip off**, the harness is tight enough.

**If you can pinch the harness strap**, tighten more.

**i**

A snug strap should not allow any slack.

It lies in a relatively straight line without sagging.

It does not press on the child's flesh or push the child's body into an unnatural position.

*continued on next page*

## FINISHED!



Your child is now secured in the car seat. Check your child's fit often and make any needed adjustments to the car seat as they grow.

### To Remove Child from Car Seat:

1. Loosen Harness Strap
2. Unbuckle Harness
3. Release Chest Clip
4. Remove Child

### Troubleshooting

**1. If the buckle or harness release lever sticks: DO NOT lubricate.** Check for dropped food, sticky spilled drinks, dirt, leaves, etc.

Clean with warm water and/ or remove the object with tweezers. If you cannot get the harness to adjust and remain tight with the buckle securely locked, **DO NOT** use this car seat.

**2. If your harness twists:** Straighten the harness each time you put your child in the car seat. Lock the buckle and tighten the harness so it will be ready for next use.



## WARNING:

Failure to fasten and tighten the harness system correctly may allow the child to be ejected from the child restraint in a crash or sudden stop causing serious injury or death.

**DO NOT** mistake comfort for safety. The harness system **MUST** be snugly adjusted.



**DO NOT** put snowsuits or bulky garments on your child when placing them in the child restraint.

Bulky clothing can prevent the harness straps from being tightened properly.

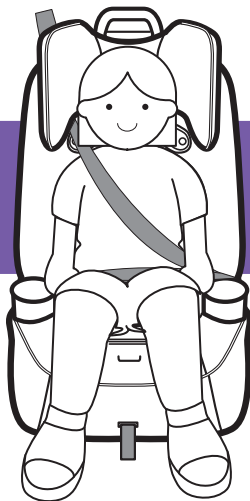

**40-100 lb (18.1-45.4 kg) and  
43-52 in. (110.1-132.1 cm)**

In this car seat, your child can remain in a **Booster Seat** until they outgrow any one of the following:

- **Weight Limit:** 100 lb (45.4 kg); **OR**
- **Height Limit:** 52 in. (132.1 cm); **OR**
- **Booster Seat Child Fit** requirements, see page 38.

You **MUST** store the harness system and remove the accessories, except the cup holder(s), when using the **Booster Seat Mode**.

To remove accessories, see page 3.

**Storing Harness System: Page 32**

**Booster Seat Use in Vehicle: Page 35**

**Booster Seat Child Fit: Page 38**

*continued on next page*

 **WARNING:**

**DO NOT** use the harness system when using as a booster seat.

**DO NOT** use LATCH when using as a booster seat. Secure the lower anchor belt and the tether strap to their storage attachments.

Use **ONLY** the vehicle's lap and shoulder belt system when restraining the child in this booster seat.

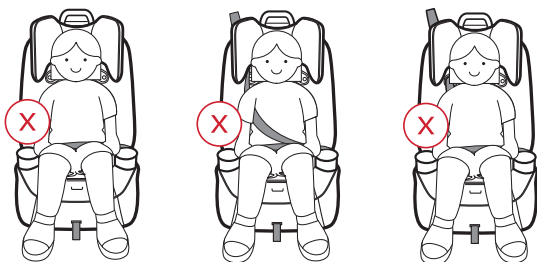

**DO NOT** use only the lap belt when using this seat as a booster seat. The shoulder belt **MUST** always be adjusted snugly across the child's chest.

**NEVER** place shoulder belt under the child's arms or behind their back.

**DO NOT** use this booster seat if the tops of your child's ears are above the top of the booster seat's headrest.

1

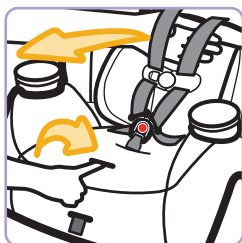

**Fully Loosen  
Harness Straps**

2

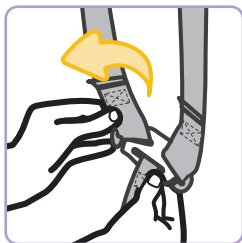

**From Back of Car  
Seat, Remove Harness  
Strap Loops from  
Splitter Plate**

3

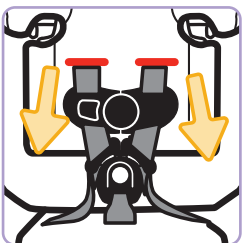

**Pull Harness Straps  
Out of Shoulder  
Harness Slots**

4

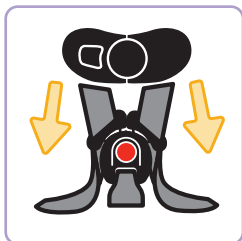

**Unthread Chest Clip  
from Harness Straps**

5

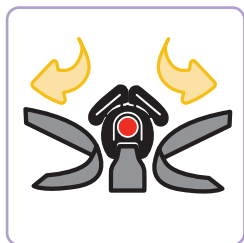

### Unthread Buckle from Harness Straps

Do not undo the buckle.

6

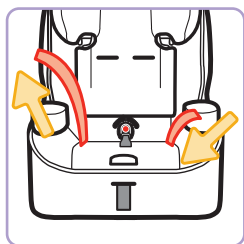

### Pull Harness Strap Out of Car Seat

7

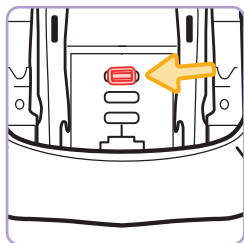

### Turn Car Seat Over

Locate the buckle's metal  
retainer on the bottom of  
the shell.

8

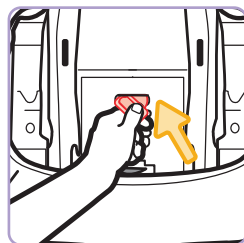

### Rotate Metal Retainer and Push It Up Through Buckle Slot in Shell

9

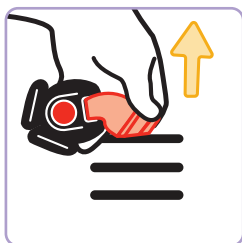

From Top of Car  
Seat, Pull Buckle  
Out of Shell  
and Pad

i

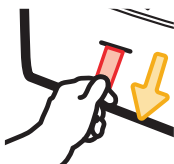

### For Booster Seat Use

Store the harness strap, chest clip, and buckle for future use.

Pull the harness adjustment strap so the splitter plate is flush against the shell as shown.



## FINISHED!

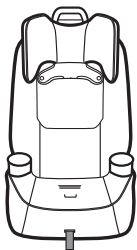

The car seat has been converted to the **Booster Seat Mode**.

See next page for **Booster Seat Use in Vehicle**.

**Please be sure to store the harness strap, chest clip & buckle with buckle tongues in a safe place for future use.**

*continued on next page*

## Booster Seat Use in Vehicle

1

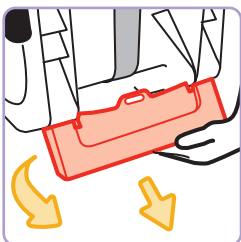

### Put Booster Seat into Upright Position

To make seat upright, on side of seat press in on round tab and rotate the recline stand down.

Push it up to lock it into place as shown.

i

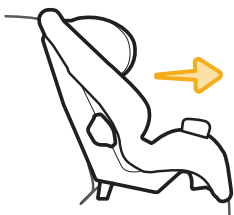

### Make Booster Seat Flush Against Vehicle Seat

The vehicle seat back **MUST** be upright.

The recline stand and front of the car seat should be flat against the vehicle seat bottom.

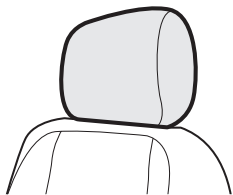

If your vehicle has a headrest that interferes with a flush car seat fit, check your vehicle owner's manual to see if it can be removed, adjusted, or if there are other possible seating locations for you to install.

2



### Have Child Sit in Booster Seat

The tops of your child's ears should never be above the top of the booster seat's headrest.

3

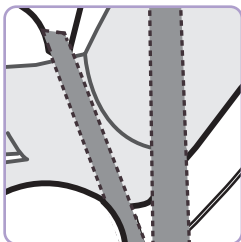

### Position Lap Belt on Child

Route the lap belt portion of the vehicle belt through the **Booster Seat Belt Path** as shown.

The lap belt should lay snugly across your child's hips, **not on their stomach**.

4

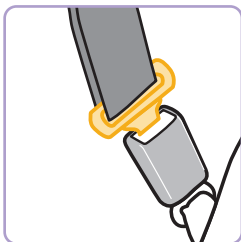

### Buckle Vehicle Belt

Pull the lap belt up to tighten.

5

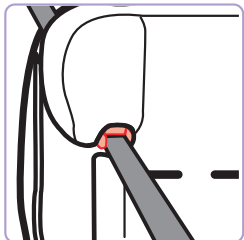
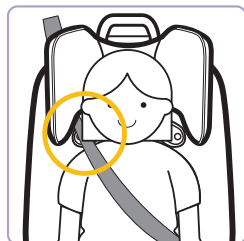

## Position Shoulder Belt on Child

Thread the shoulder belt through the belt-positioning guide in the headrest.

Pull the shoulder belt up to tighten so that it lies snugly across the center of your child's shoulder and across their chest.

## FINISHED!



Check periodically to make sure your child has not moved out of position and loosened the shoulder belt.

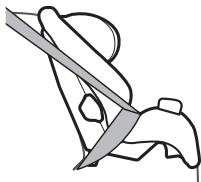

Keep the booster seat securely belted even when unoccupied.

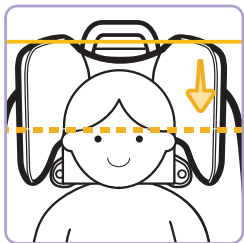

## Head Position

The tops of your child's ears should **never be above** the top of the booster seat's headrest.

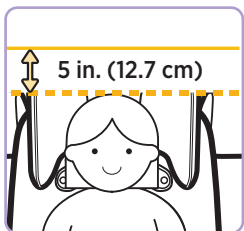

## Car Position

**DO NOT** use the booster seat if your child's head is less than 5 in. (12.7 cm) below the roof of the car.

Consult your vehicle manual for proper seatbelt usage.

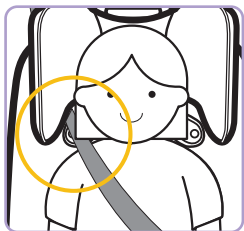

## Shoulder Belt Position

The shoulder belt should lay snugly across the center of your child's shoulder and across their chest.

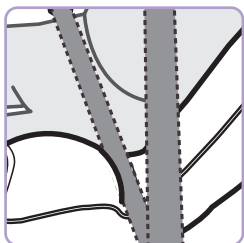

## Lap Belt Position

The lap belt should lay snugly across your child's hips, **not on their stomach.**

## Changing Headrest/ Harness Height

1

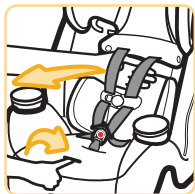

### Fully Loosen Harness Straps

Push down on the harness release lever (through the opening in the pad) while pulling out on the harness straps as shown.

2

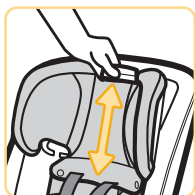

### Adjust Headrest/ Harness Height

1. Squeeze the adjustment handle lever up.
2. Move the headrest up or down to the proper height for your child.
3. Release the handle to lock in place.
4. Make sure it is locked securely.

i

### To Use Headrest in Lower Positions:

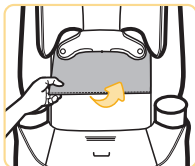
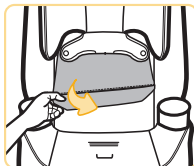

Fold bottom of headrest pad up underneath middle section of headrest pad as shown.

**For Rear-Facing Child Fit**, see page 8.

**For Forward-Facing Child Fit**, see page 18.

To learn how to check harness tightness, see pages 27-29.

If you cannot achieve a snug harness fit for your child, see pages 39-43.

Check the harness straps often for any wear or damage.



## WARNING:

Failure to place buckle's metal retainer completely through pad and child restraint can result in serious injury or death.

1



### Undo Buckle

It may be easier to undo the buckle by pressing in towards the top of the button.

2

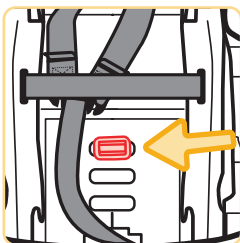

### Turn Car Seat Over

Locate the buckle's metal retainer on the bottom of the shell.

3

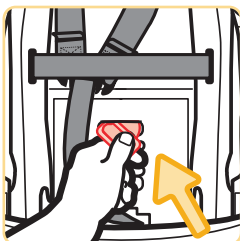

### Rotate Metal Retainer and Push It Up Through Buckle Slot in Shell

4

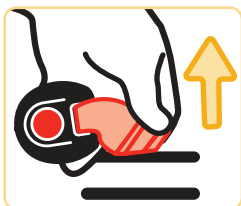

From Top of Car Seat, Pull Buckle Out of Shell and Pad

5



Insert Buckle's Metal Retainer into Buckle Slot Closest to Child

The buckle **must** face out.

**Rear-Facing Mode:** You **must** use the 1st or 2nd buckle slot.

**Forward-Facing Mode:** Any slot can be used.

6

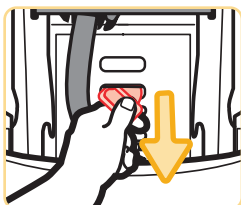

Pull Metal Retainer Completely Through Pad and Shell

7



**Check Buckle**

Pull the buckle up to make sure it is secured.

The buckle **MUST NOT** pull out.

**i**

**For Rear-Facing Child Fit,** see page 8.

**For Forward-Facing Child Fit,** see page 18.

To learn how to check harness tightness, see pages 27-29.

If you cannot achieve a snug harness fit for your child, see pages 39-43.



If you cannot achieve a snug harness fit for your child, you may need to adjust the buckle strap and location as shown in this section.



### WARNING:

The harness system **MUST** be installed correctly.

**DO NOT** use a child restraint with damaged harness straps.

Failure to place buckle's metal retainer completely through pad and child restraint can result in serious injury or death.

1

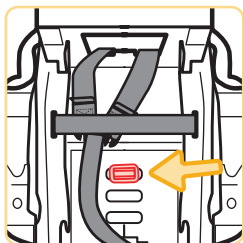

#### With Buckle in 1st Slot, Fully Recline Car Seat

If you need to move the buckle to the 1st slot, see pages 40-41.

2

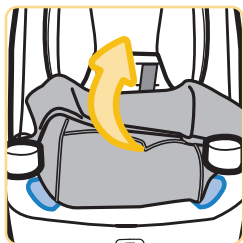

#### Pull Front of Car Seat Pad Up

*continued on next page*

3

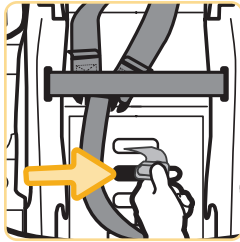

### Reach Under Car Seat

Pull the buckle's metal retainer down and then push it up into the middle slot as shown.

4

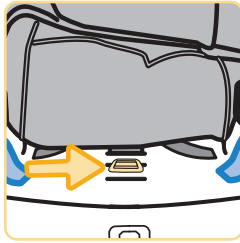

### From Top of Car Seat, Lay Metal Retainer Flat Against Car Seat

5



### Tuck Car Seat Pad Around Front of Car Seat & Check Buckle

Pull the buckle up to make sure it is secured.

The buckle **MUST NOT** pull out.

# Reclining Car Seat

44

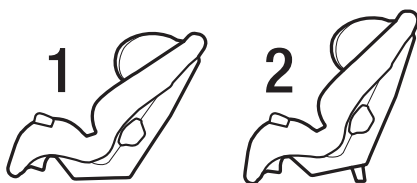

This car seat has 2 positions.

**Rear-Facing Mode** - 1 Reclined

**Forward-Facing Mode** - 2 Upright

**Booster Seat Mode** - 2 Upright

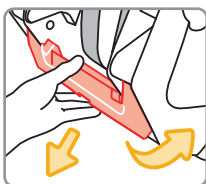

**To Recline:** Pull the recline stand down, rotate it, and store it under the car seat.

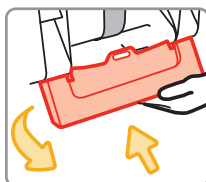

**For Upright:** On side of the car seat press in on the round tab and rotate the recline stand outward.

Push it up to lock it into place as shown.

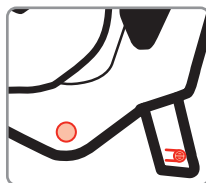

## Removing Seat Pad Set



You do not need to remove the harness system to remove the pad from the car seat. **To remove accessories**, see page 3.

1

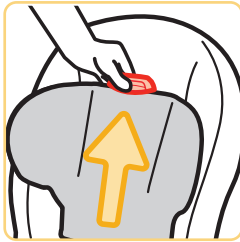

**Adjust Headrest to Highest Position**

2

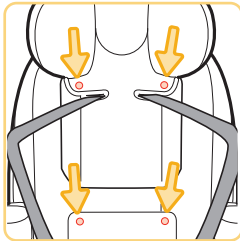

**On Select Models:  
Undo Fasteners on  
Headrest Pad &  
Seat Pad**

3

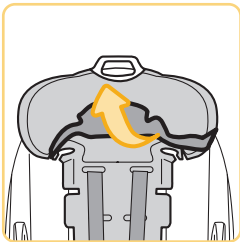

**Gently Pull  
Headrest Pad  
Off Bottom  
of Headrest**

4

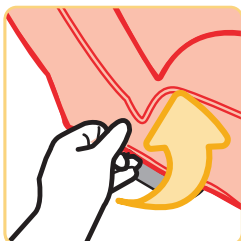

**Pull Seat Pad Off  
Sides & Front of  
Car Seat**

5

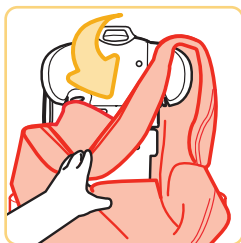

**Pull Seat Pad  
Around Headrest  
& Off of Car Seat**

**i**

**If harness straps have been removed from chest clip & buckle, rethread them:**

The harness strap ends go through the **back** of the buckle tongues & through the chest clip **front to back**.

**See Installing Harness Straps, pages 49-52.**

## Cleaning Parts of Car Seat & Installing Seat Pad Set

### Cleaning Pad & Accessories

Machine wash separately with cold water on a gentle cycle. **DO NOT** use bleach. Tumble dry separately for 10-12 minutes on low heat. Remove immediately.

### Cleaning Harness Strap

**Check the harness straps often for any wear or damage.**

Spot clean using warm sudsy water and damp cloth. Spilled food and liquids on the car seat may result in mold or bacterial growth over time. These spills could also attract insects or rodents.

### Cleaning Buckle & Car Seat

Spot clean using warm sudsy water and damp cloth. **DO NOT** submerge into water.

### Installing Seat Pad Set

1. Lower Headrest to Middle of Car Seat
2. Pull Seat Pad Around Headrest and onto Car Seat
3. Pull Headrest Pad onto Headrest



## WARNING:

**DO NOT** use the child restraint without the seat pad or with damaged harness straps.

## Installing Buckle

1

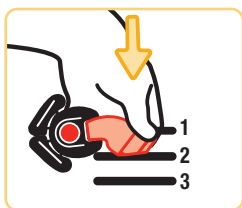

### Insert Buckle's Metal Retainer into Buckle Slot Closest to Child

The buckle **must** face out.

**Rear-Facing Mode:**  
You **must** use the 1st or 2nd buckle slot.

**Forward-Facing Mode:**  
Any slot can be used.

2

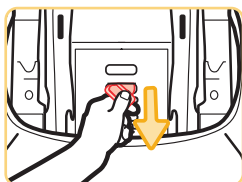

### Pull Metal Retainer Completely Through Pad and Shell

3



### Check Buckle

Pull up on the buckle to make sure it is secured.

The buckle **must not** pull out.



## WARNING:

The harness system must be installed correctly.  
**DO NOT** use a child restraint with damaged harness straps.

### Installing Harness Straps

1

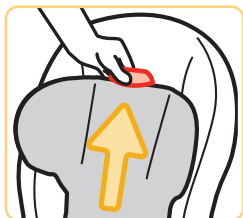

**Adjust Headrest to Highest Position**

2

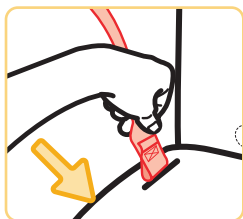

**Thread Harness Strap into Hip Harness Slot**

With the sewn end of the harness strap loop facing the buckle, thread the harness strap down through the hip harness slot as shown.

3

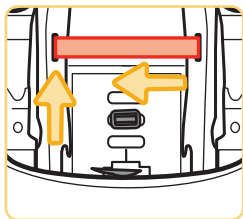

### Turn Car Seat Over and Pull Harness Strap Across Bottom of Shell

Push the harness strap up through the other hip harness slot.

4

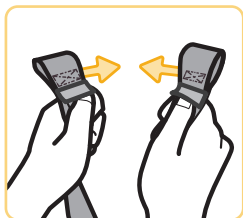

### Make Harness Strap Ends Even

The sewn end of the harness strap loops **must** face each other.

5

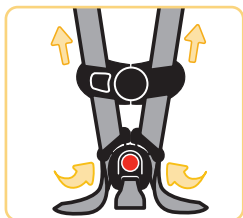

### Thread Buckle and Chest Clip

The harness strap ends go through the **back** of the buckle tongues and through the chest clip **front to back** as shown.

6

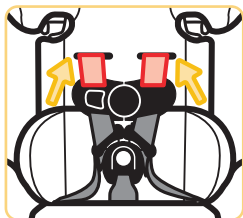

### Thread Harness Straps into Shoulder Harness Slots

7

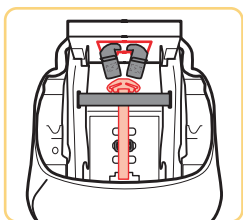
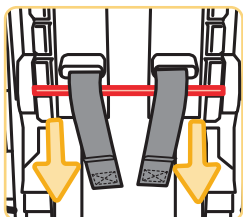

### From Back of Car Seat, Thread Harness Straps Over Metal Bar

**Do not** twist the harness straps.

The harness adjustment strap and the splitter plate **must be** behind the harness strap as shown.

The harness strap loop ends **must** go through the recline stand as shown.

8

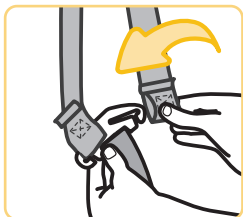

### Attach Harness Strap Loops to Splitter Plate As Shown

The sewn ends of the harness strap loops **must** face towards you.

**Do not** twist the harness strap or the harness adjustment strap.

Make sure the harness strap loops are fitted **completely on** both sides of the splitter plate.



**Check your child's fit often.**

**To learn how to check harness tightness, see pages 27-29.**

**If you cannot achieve a snug harness fit for your child, see pages 39-43.**

**Check the harness straps often for any wear or damage.**

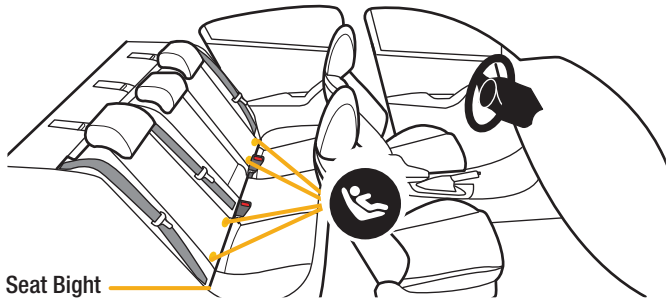

Your vehicle's features may be considerably different than those pictured here.

The lower anchors of **LATCH** (**L**ower **A**nchors and **T**ethers for **C**hildren) is a universal system for installing car seats without using vehicle seat belts. The LATCH: lower anchor belt can **ONLY** be used in vehicles that have the lower anchor bars installed in designated seating positions. Most vehicles manufactured after September 2002 are equipped with LATCH: lower anchor bars. Check your vehicle owner's manual to see which seating positions may be equipped with LATCH: lower anchor bars.

#### Lower Anchor Belt Storage Location

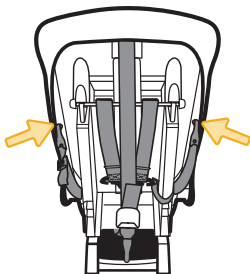

#### Lower Anchor Belt Parts

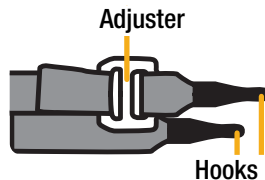

#### To Remove Lower Anchor Belt from Storage Location on Car Seat

Squeeze the spring lever on the hooks and remove the hooks from the attachments in the storage location.

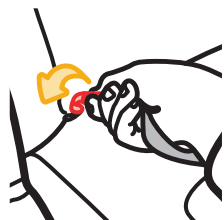
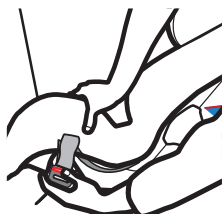

### To Remove Lower Anchor Belt from Vehicle's Lower Anchor Bars

1. Remove the tension from the belt by pushing down on the side of the car seat with the adjuster.
2. Then press the adjuster's button to loosen the belt.
3. Squeeze the spring lever on the hooks, push the hooks back into the vehicle seat, and rotate the hooks to the side.
4. Pull the hooks out of the vehicle seat.

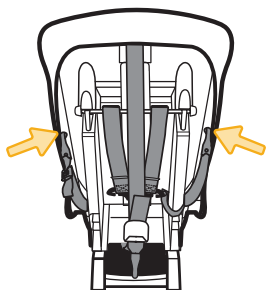

### To Store Lower Anchor Belt

The lower anchor belt **MUST** be properly stored in its storage location when:

- using the vehicle belts to install the car seat; **OR**
- using the **Booster Seat Mode**; **OR**
- the car seat is not installed in a vehicle.

Secure the hooks to the attachments in the storage location as shown. Gently tighten the belt to remove slack.



## WARNING:

**DO NOT** use both the lower anchor belt and vehicle belt at the same time.

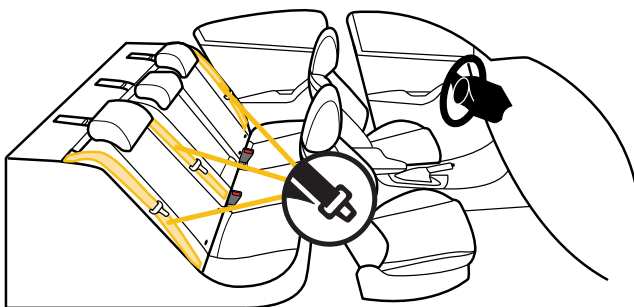

Your vehicle's features may be considerably different than those pictured here.

If LATCH: lower anchors are not an option or if your child weighs more than **55 lb** (24.9 kg), you **MUST** use the vehicle seat belt system to install the car seat.

**Not all vehicle belts and seating positions will work with car seats. Please go through the following steps to understand how to lock a car seat in **Rear-Facing Mode** or **Forward-Facing Mode** with a vehicle belt.**

1

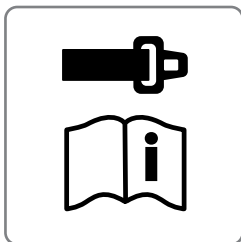

### You **MUST** Review Your Vehicle Owner's Manual

Your vehicle owner's manual will let you know which vehicle belts and seating positions car seats can be installed in.

2



### Check How This Car Seat Will Be Locked Into Place

The vehicle belt **MUST NOT** loosen after tightening.

This means there needs to be a way to lock the vehicle belt.

#### The ways this can be done are:

- By using the seat belt's retractor (see step 3); **OR**
- By using the seat belt's latch plate (see step 4).

3

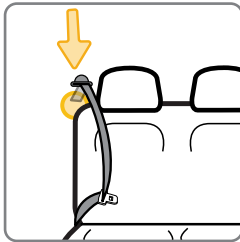

### Check Retractor

Retractors pull seat belts into stored positions and lock the belt to hold passengers in place.

See the next page for some common types of vehicle belt retractors that will work with this car seat.

## Types of Retractors

### Switchable Retractor

(most vehicles have this type)

This retractor can be switched to a locking mode.

You **MUST have the retractor in the locking mode** to use the seat belt with this car seat.

**Switching to locking mode:** Slowly pull the shoulder belt all the way out, then let it go back in **1-2 in.** (2.5-5 cm).

As it goes back in, you will most likely hear a ratcheting sound.

Gently pull the belt to see if it has locked. You will not be able to pull any more belt out if the lock has engaged.

### Automatic Locking Retractor

This retractor always locks.

It will automatically lock after slowly pulling the seat belt out at least halfway and letting the belt go back into the retractor **1-2 in.** (2.5-5 cm).

### Emergency Locking Retractor

#### See Step 4

#### “Check Latch Plates”

If the retractor does not lock, it is most likely an Emergency Locking Retractor. These retractors only lock during a sudden stop or collision.

You will need to determine if your seat belt's latch plate can lock the belt. See step 4, “Check Latch Plates”.

4

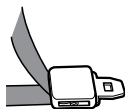

Locking  
Latch  
Plate



Emergency  
Locking  
Retractor with  
a Sliding Latch  
Plate

## Check Latch Plates

Latch plates are the part of the seat belt that goes into the buckle.

**To see if the latch plate locks:**

1. Buckle Vehicle Belt
2. Firmly Tug Lap Portion of Seat Belt While Pulling It Up

If the vehicle belt does not slide through the latch plate, it's locked.

If the latch plate slides up and down the vehicle belt, it is a **sliding latch plate**.

Sliding latch plates easily slip between the lap and shoulder portions of the belt.

i

**If you have an Emergency Locking Retractor with a Sliding Latch Plate, you MUST use a locking clip.**

**Please contact us for one, see the back cover of the manual.**

### **Never Use the Following With This Car Seat:**

- Emergency Locking Retractor Lap Only Belt
- Inflatable Seat Belts

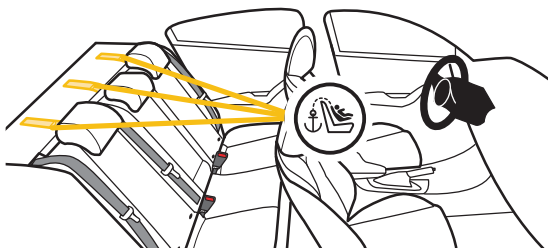

Your vehicle's features may be considerably different than those pictured here.

When anchors are available, you **MUST** always attach, adjust, and secure the tether (top anchorage) strap when installing the car seat in the **Forward-Facing Mode** with internal harness. Tethers improve the installation and stability of car seats and reduce the risk of injury. Attach the tether hook to the tether anchor designated by your vehicle manufacturer for that seating position. Check your vehicle owner's manual for more information. If the seating position does not have a tether anchor, use a different seating position or see your dealer or a qualified mechanic and have one installed.

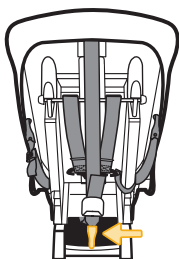

### Storing Top Tether Strap

The tether strap **MUST** be properly stored in its storage location when:

- installing in **Rear-Facing Mode**; **OR**
- using the **Booster Seat Mode**; **OR**
- the car seat is not installed in a vehicle.

Attach the tether hook to its storage location as shown. Gently tighten to remove slack.



## WARNING:

Using this child restraint without the tether strap anchored as required by the manufacturer would be a misuse of the child restraint and, in a sudden stop or crash, could result in serious injury or death.

**DO NOT** fasten multiple tether hooks on the same tether anchor in the vehicle.



### WARNING:

**NEVER** take your child out of the child restraint while the vehicle is moving.

**NEVER** leave your child unattended. Placing your child in a hot child restraint may result in burns.

**DO NOT** use a child restraint with damaged or missing parts.

**DO NOT** use a child restraint with cut, frayed, or damaged harnesses.

**DO NOT** substitute parts or try to modify the child restraint in any way. **DO NOT** lubricate buckles and fasteners.

**DO NOT** use any child restraint accessory except those approved by Dorel Juvenile Group.

**NEVER** allow any child to play with this child restraint; it is not a toy.

**DO NOT** remove or cover up any of the warning labels or other labels on the child restraint.

This child restraint has been certified for use in passenger vehicles. **DO NOT** use in a boat, on a motorcycle or in a cargo van or bus where there are no seat belts or tether anchors.

Read all instructions for additional warnings.

## Vehicle Seating Position



### WARNING:



**NEVER** place a child rear-facing in a seating position with an active frontal air bag.



Check the vehicle owner's manual for more information about air bag/child restraint use.



Use the child restraint only on vehicle seats that face forward.

**DO NOT** use on seats that face the sides or rear of the vehicle.

For vehicles without a back seat, refer to your vehicle owner's manual.



Children are safer when properly restrained in rear seating positions than in the front seating positions.

According to accident statistics, children in rear seating positions are statistically safer, whether you have air bags, advanced air bags, or no air bags at all.

If you are not sure where to place the car seat in your vehicle:

- Consult your vehicle owner's manual; **OR**
- Contact Dorel Juvenile Group Consumer Care Department; **OR**
- Visit your local Child Passenger Inspection Station. Go to <https://www.nhtsa.gov/equipment/car-seats-and-booster-seats> to find your closest station.

**To avoid your child being seriously burned, take the following precautions:**

- Park in the shade or where the sun does not directly hit the car seat.
- Cover the car seat with a sheet or blanket when not in use.
- Check for hot seat and buckles before placing child in car seat.

**To help protect your vehicle seat's upholstery from damage:** you may use an accessory approved by Dorel Juvenile Group or a single layer towel underneath and behind car seat.

## Installation in Vehicle



### WARNING:

Check the vehicle belt or lower anchor belt before each use. Use only if the belt can be tightened properly and locked securely in place.

Even when unoccupied, this child restraint **MUST** be firmly secured to the vehicle with the lower anchor belt or with the vehicle seat belt.

Even when unoccupied, this booster seat **MUST** be firmly secured to the vehicle with the vehicle seat belt.

In a crash or sudden stop, an unsecured child restraint or booster seat could injure occupants.

### DO NOT risk your child's safety.

To keep your child as safe as possible, Dorel Juvenile Group strongly recommends replacing the car seat even after a minor crash; even if it was not occupied at the time.

#### Replacement After a Minor Crash

The National Highway Traffic Safety Administration states that for a crash to be considered minor **ALL of the following MUST be true:**

- Vehicle able to drive away from the crash site; **AND**
- Vehicle door nearest the car seat was not damaged; **AND**
- No passengers were injured; **AND**
- Airbags did not deploy; **AND**
- There is no visible damage to the car seat.

If the crash your car seat was involved in meets **ALL** the criteria, you may not need to replace the car seat.

If one or more of these criteria are not true or if you are uncertain of any of your answers, replace the car seat immediately.

#### Replacement After a Moderate to Severe Crash

You **MUST** replace this car seat if it has been in a moderate to severe car crash.

This car seat is intended to protect a child in a single crash. During a crash, the car seat and all of its parts absorb crash energy which can deform or weaken it. Damage is not always visible. A damaged car seat **MUST** be replaced immediately.

#### Expiration



On the side of the car seat there is a date of manufacture label as shown.

**DO NOT** use this car seat more than 10 years after the date of manufacture.

# Registration & Safety Notices

64

0515079 *Tear Off and Mail This Part or Register Online* 4348-0081D

**Consumer:** Just fill in your name, address and email. Please print (use dark ink).

Your Name  
[Grid]

Your Street Address  
[Grid]

City [Grid] State [Grid] Zip Code [Grid]

Email Address (optional)  
[Grid]

---

| Model Number | Model Name    | Manufacture Date |
|--------------|---------------|------------------|
| AB123CDE     | BRAND CARSEAT | 05/16/2015       |

**Example of model number, manufacture date, and line code.**



If you don't have the card or if your address changes, you will find the model number, manufacture date, and line code on the label located on the side of the car seat.

Please complete the postage-paid registration card that came with your child restraint, and send it to us.

Child restraints could be recalled for safety reasons.

You must register this restraint to be reached in a recall.

Send your name, address, e-mail address if available and the restraint's model number and manufacturing date to:

**Dorel Juvenile Group**

2525 State Street  
Columbus, IN 47201

or call 1-800-544-1108 or register online at [www.djgusa.com/registration/carseat/us](http://www.djgusa.com/registration/carseat/us).

For recall information, call the U.S. Government's Vehicle Safety Hotline at 1-888-327-4236 (TTY: 1-800-424-9153), or go to [www.NHTSA.gov](http://www.NHTSA.gov).



This restraint is certified for aircraft use when used with the internal harness.

Install the car seat in a window seat to avoid blocking the aisle. If the aircraft lap belt is too short, ask the flight attendant for a belt extender.

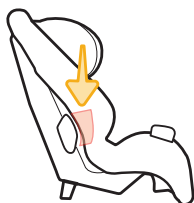

Use only on forward-facing aircraft seats. Contact the airline for their specific policies.

Some airlines may ask to see a label stating that this car seat is certified for aircraft use.

There is an airplane certification label located on the side of this car seat shell as shown.



## WARNING:

Store the lower anchor belt and tether strap when installing with aircraft belts.



### Rear-Facing Aircraft Installation

Follow the vehicle belt install steps on pages 10-15.



### Forward-Facing Aircraft Installation

Follow the vehicle belt install steps on pages 20-26, skipping the tether strap steps.



### Booster Seat

This restraint is not certified for aircraft use when used as a booster seat because aircraft seats do not have shoulder belts.

Dorel Juvenile Group, Inc. (DJG) warrants this product to the original retail purchaser as follows: This product is warranted against defective materials or workmanship for one year from the date of original purchase.

**An original receipt is required to validate your warranty.**

DJG will, at its option, provide replacement parts or replace this product. DJG reserves the right to substitute if the part or model has been discontinued.

To make a claim under this warranty, please contact our Consumer Care Department by phone: 1-800-544-1108 or text: 1-812-652-2525. Our hours of operation are from 8:00 a.m. to 6:00 p.m. EST Monday through Thursday and from 8:00 a.m. to 4:30 p.m. on Friday.

**Proof of purchase is required and shipping charges are the responsibility of the consumer.**

**Warranty Limitations:** This warranty does not include damages which arise from misuse or abuse of this product.

**Limitation of Damages:** The warranty and remedies as set forth are exclusive and in lieu of all others, oral or written, expressed or implied. In no event will DJG or the dealer selling this product be liable to you for any damages, including incidental or consequential damages, arising out of the use or inability to use this product.

**Limitation of warranties and other warranty terms and state law rights:** Any implied warranties, including implied warranties of the merchantability and fitness for a particular purpose, shall be limited to the duration and terms of the express written warranty.

Some states do not allow limitations as to how long an implied warranty lasts or the exclusion or limitation of incidental or consequential damages, so the above limitations may not apply to you. This warranty gives you specific legal rights, and you may have other rights, which vary from state to state.

Neither DJG nor the dealer selling this product authorized any person to create for it any other warranty, obligation, or liability in connection with this product.