

[®]
COSCO

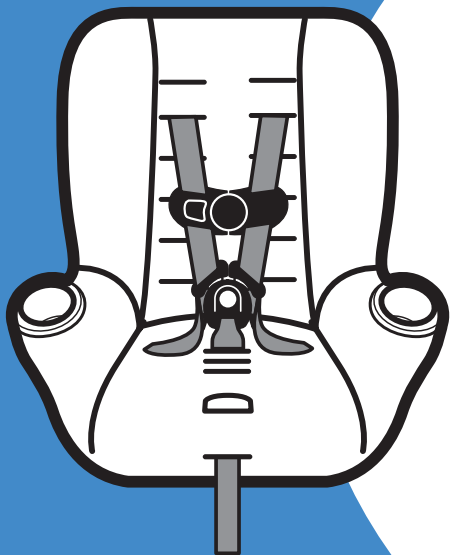

Onlook

2-in-1 Convertible Car Seat

Your model may look different than one shown on cover.

Read all instructions BEFORE USING this car seat.

KEEP INSTRUCTIONS FOR FUTURE USE.

 **Failure to follow the warnings on the labels and in the instruction manual can result in serious injury or death to your child.**

4358-8238A 2.22.22



Welcome to the Cosco Family!

Thank you for choosing this car seat, also known as a child restraint!

To help you get started using your child's new car seat, here are the 4 main tasks you'll need to complete.

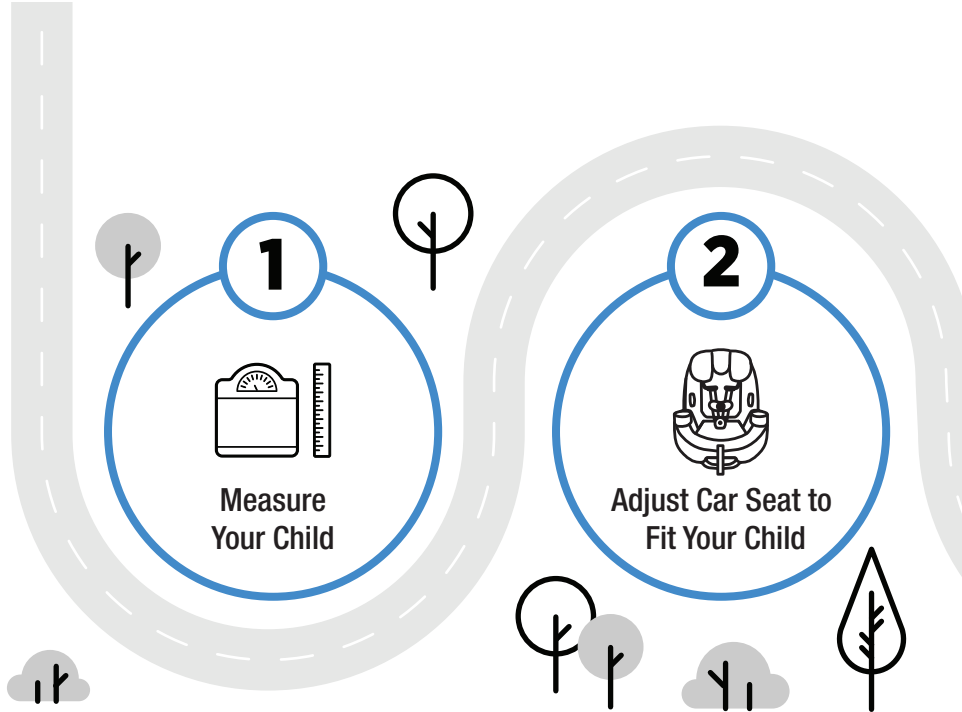



3



**Install Car Seat
into Your Vehicle**

4

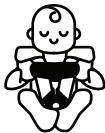

**Secure Your Child
in Car Seat**



Your child's safety is worth the time it will take to read and follow these instructions.

Ready? Let's go!

Pages 1-4 will introduce you to the parts of the car seat.

The Back Cover of this Manual has our contact information.

If at any point you would like assistance, please feel free to reach out to us.

Contents

- 1 Getting Started**

 - 1 Parts of Car Seat
 - 4 Accessory Use
 - 5 Choosing Car Seat Mode

- 7 Rear-Facing Section**

 - 9 [Rear-Facing Child Fit](#)
 - 11 [Rear-Facing Vehicle Install](#)

- 19 Forward-Facing Section**

 - 21 [Forward-Facing Child Fit](#)
 - 23 [Forward-Facing Vehicle Install](#)

- 30 Securing Child in Car Seat**

- 33 Making Adjustments to Car Seat**

 - 33 Changing Harness Height
 - 36 Changing Buckle Position
 - 39 Harness System Adjustments for Smaller Infants

- 44 Wash & Care**

 - 44 Removing Harness System & Seat Pad
 - 47 Cleaning Parts of Car Seat
 - 48 Installing Seat Pad & Harness System

51 LATCH & Vehicle Belt Information

51 LATCH: Lower Anchor Belt

53 Vehicle Belts

57 Top Tether

58 Safety Information

58 Child Restraint Use

59 Vehicle Seating Position

60 Installation in Vehicle

61 Replacement & Expiration

62 Registration & Safety Notices

63 Aircraft Information

64 Warranty

66 Replacement Parts List

©2021 Dorel Juvenile Group, Inc. (800) 544-1108 www.coscokids.com. Styles and colors may vary. Los estilos y los colores pueden variar. Made in USA from American and imported parts (including seat pad). Hecho en EE.UU. a partir de piezas americanas e importadas (incluyendo la almohadilla del asiento). Distributed by (distribuido por) Dorel Juvenile Group, Inc., 2525 State St., Columbus, IN 47201-7494. Dorel Juvenile Canada, 2233 Argentia Road, Suite 110, Mississauga, ON L5N 2X7. Importado y Distribuido en Chile por: Comercial e Industrial Silfa S.A. - San Ignacio 0201 / Parque Industrial Portezuelo Quilicura, Santiago Chile. Fono (562) 2339 9000. En Perú por: Comexa S.A. - Los Libertadores 455 - San Isidro, Lima - Perú. Fono (511) 4469014. En Centro América, Caribe y Ecuador por: Best Brands Group S.A. - Av. Balboa, Bay Mall Plaza, Planta Baja, local 9, Panamá. - Fono: (507) 300 2884. En Colombia por: Baby Universe S.A.S. - Vía 40 No. 77-29, Barranquilla, Colombia - Fono: (575) 353 1110 Importador: DJGM, S.A. DE C.V. Gabriel Mancera No. 1041 Col. Del Valle, Benito Juárez C.P. 03100 México, Ciudad de México R.F.C. DJG140305GN9 Tel. (55) 6719920



Parts of Car Seat

1

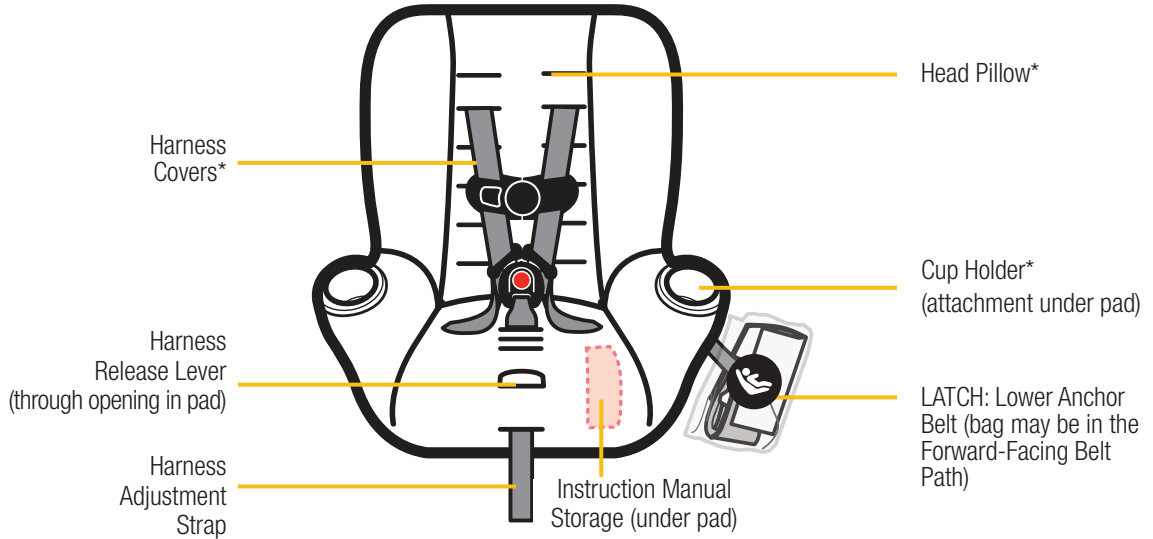

Your model may look different than one shown.

*See pages 3-4 for Accessory Use.

Harness System

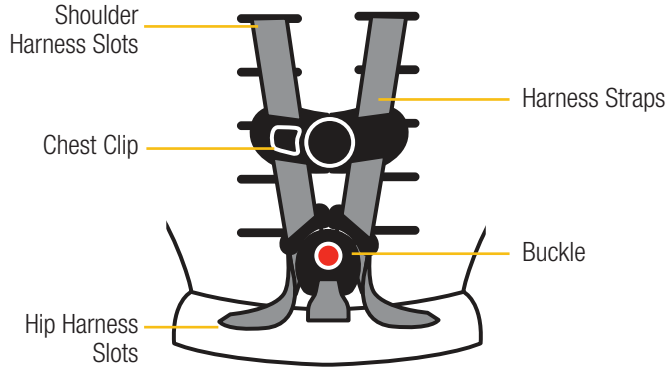

*See page 4 for Accessory Use.

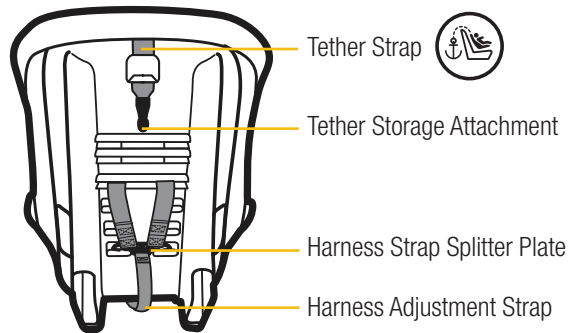
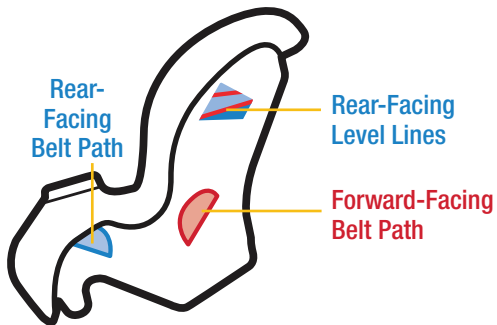

Accessory Use

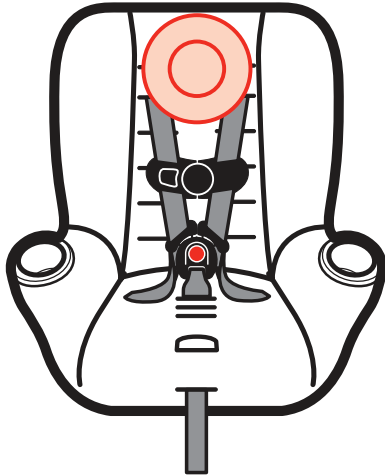

Head Pillow
(on select models)

Only For Use in
Rear-Facing Mode

To remove, from the back of the head pillow gently pull the fabric tabs out of the shoulder harness slots.

To attach, slide the fabric tabs into the shoulder harness slots.

WARNING:

Measure your child's weight and height (**DO NOT** guess) before choosing this car seat's mode.

Your child's height, weight, and age determine how the car seat should be placed in the vehicle.

Children vary widely in body size, shape, and temperament—**please consult your doctor before switching between any modes within the limits and fit requirements of the car seat.**

State Laws

Please be certain to follow your state's laws regarding car seat use.

American Academy of Pediatrics Recommendations

Infants and Toddlers

Should ride in a rear-facing car seat as long as possible, until they reach the highest weight or height allowed by their car seat.

Toddlers and Preschoolers

Once they are facing forward, children should use a forward-facing car seat with a harness for as long as possible, until they reach the height and weight limits for their car seats.

School-Aged Children

Once they have outgrown their forward facing car seat, children should use a belt-positioning booster seat until the vehicle's lap and shoulder seat belt fits properly. This is often when they have reached at least 4 feet 9 inches in height and are 8 to 12 years old.

Older Children

All children younger than 13 years should be restrained in the rear seats of vehicles for optimal protection.



Rear-Facing Mode

5-40 lb (2.3-18 kg) **and**
19-40 in. (48-101.6 cm)

Rear-Facing Section

PAGE 7

Rear-Facing Child Fit

PAGE 9

Rear-Facing Vehicle Install

PAGE 11



Forward-Facing Mode

22-40 lb (10.1-18 kg) **and**
29-43 in. (73.6-110 cm) **and**
at least 1 year old

Forward-Facing Section

PAGE 19

Forward-Facing Child Fit

PAGE 21

Forward-Facing Vehicle Install

PAGE 23

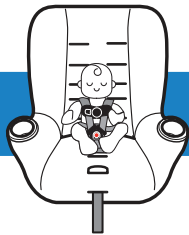

5-40 lb (2.3-18 kg) **and 19-40 in.** (48-101.6 cm)

Children under 1 year of age **MUST** ride **Rear-Facing**.

In this car seat, your child can remain **Rear-Facing** until they outgrow any one of the following:

- **Weight Limit:** 40 lb (18 kg); **OR**
- **Height Limit:** 40 in. (101.6 cm); **OR**
- **Rear-Facing Child Fit** requirements, see page 9.

Before installing the car seat in your vehicle, check your child's fit in the car seat.

This way you won't have to redo the vehicle installation to make adjustments to the car seat.

Rear-Facing Child Fit: Page 9

Rear-Facing Vehicle Install: Page 11

WARNING:



NEVER install a rear-facing child restraint in the front seat of a vehicle equipped with an active frontal airbag.

DO NOT use the tether for rear-facing mode. Secure the tether strap hook to its storage attachment.

DO NOT use the lower anchor belt along with the vehicle lap or lap/shoulder belt.

DO NOT fasten multiple lower anchor hooks on the same lower anchor bar in the vehicle.

Check the vehicle belt or the lower anchor belt before each use. Use **ONLY** if the belt can be tightened properly and locked securely in place.

Even when unoccupied, this child restraint **MUST** be firmly secured to the vehicle with the lower anchor belt or with the vehicle seat belt.

This child restraint **MUST ALWAYS** face the rear of the vehicle until the child is at least 1 year old and weighs 22 lb (10 kg).

1

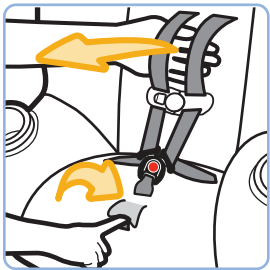

Fully Loosen Harness Straps

Push down on the harness release lever (through the opening in the pad) while pulling out on the harness straps as shown.

2

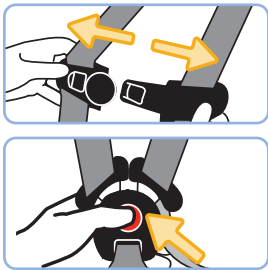

Undo Chest Clip & Buckle

It may be easier to undo the buckle by pressing in towards the top of the button.

3

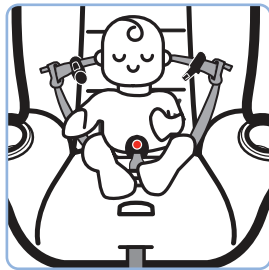

Place Child in Car Seat

Your child's bottom and back should be flat against the car seat.

4

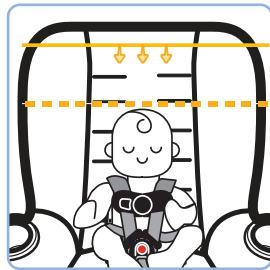

Check Head Position

The top of your child's head **MUST be at least 1 in. (2.5 cm) below** the top of the car seat.

5

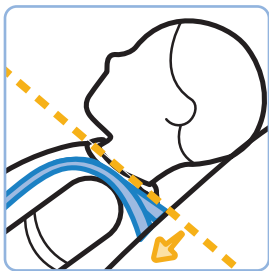

Check Harness Strap Position

The harness strap **MUST** be **at or slightly below** the shoulders; never above.

6

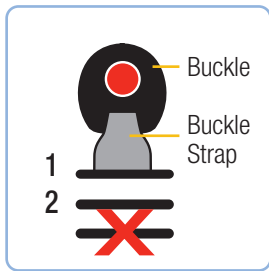

Check Buckle Position

- Use the slot closest to your child.
- The buckle **should not be underneath or behind** your child.

DO NOT use the 3rd buckle slot in **Rear-Facing Mode**.

i

To change the harness strap height, see pages 33-35.

To change the buckle position, see page 36-38.

To learn how to check harness tightness, see pages 30-32.

If you cannot achieve a snug harness fit for your child, see pages 39-43.



Before installing the car seat in your vehicle, check to see if you need to adjust the buckle position or harness height for your child. **See page 9 for child fit.**

Once the car seat is installed, you will not be able to adjust the buckle position or the harness strap height.

Review Vehicle Owner's Manual

Determine what kind of vehicle belts your car has and how to use them to lock a car seat in place **OR** where LATCH: lower anchor seating positions are located in your vehicle.

There are 2 different methods for install.

Use only one:



Vehicle Belt



LATCH: Lower Anchor Belt

WARNING:

DO NOT use both the LATCH: lower anchor belt and vehicle belt at the same time to install the car seat.

1



Place Car Seat **Rear-Facing** in Back Seat

For children who weigh between 5-22 lb (2.3-10 kg), the bottom level line **MUST** be parallel with the ground.

For children who weigh between 22-40 lb (10.1-18 kg) and can sit

2

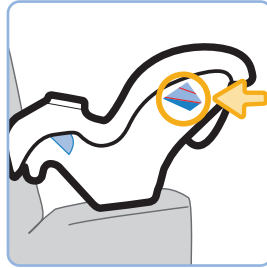

Check **Rear-Facing Level Lines**

up unassisted, rotate the car seat between the 2 level lines. Start by making the bottom level line parallel with the ground and then rotate the car seat up.

DO NOT rotate past the top level line.

continued on next page

3

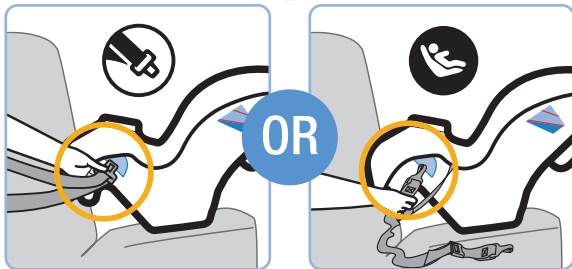

Locate **Rear-Facing Belt Path** & Route Vehicle Belt or Lower Anchor Belt Through It

For the LATCH belt: You may need to fully lengthen the belt before routing it into the belt path. Squeeze the adjuster button and pull the belt out as shown.



4

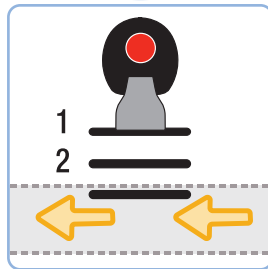

Vehicle Belt or Lower Anchor Belt Goes:

- under the car seat pad; **AND**
- across the car seat; **AND**
- in front of the buckle; **AND**
- out the other **Rear-Facing Belt Path** opening.

DO NOT twist the belt.

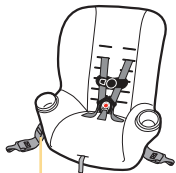

Adjuster

Finished Lower Anchor Belt Routing

The lower anchor belt adjuster can be on either side of the car seat.

5

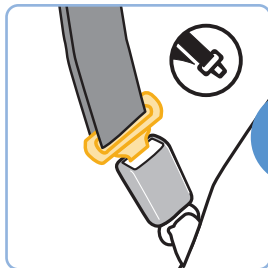

OR

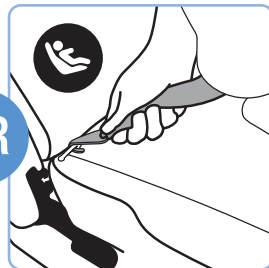

Buckle Vehicle Belt

If your car has a **switchable retractor**, use it to lock the vehicle belt. Review page 55 of this manual or your vehicle owner's manual.

Attach Lower Anchor Belt Hooks to Vehicle's Lower Anchors

continued on next page

6

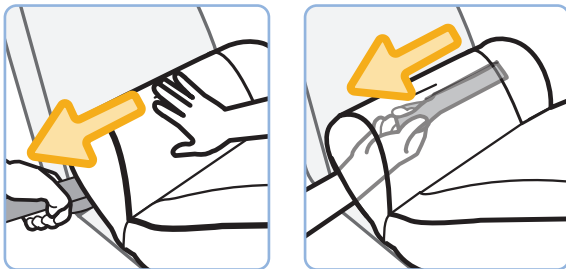

Tighten Belt

Place your hand in the car seat and firmly push the car seat down and back towards the vehicle seat. Pull the belt towards you and parallel (in line) with the belt path as shown.

For the LATCH belt or Lap Only Vehicle Belt: it may be easier to tighten if you route the free end of the belt back into the **Rear-Facing Belt Path**, reach into the **Rear-Facing Belt Path**, and pull the free end of the belt towards you.

7

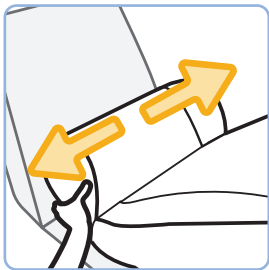

Check Belt Tightness

Hold the **Rear-Facing Belt Path** with your non-dominant hand. Push and pull the car seat from side to side.

The car seat should not move more than **1 in.** (2.5 cm).

i

If the car seat moves more than 1 in. (2.5 cm), you can try:

- Pulling the belt tighter; **OR**
- Reinstalling the car seat; **OR**
- Changing to a different seating location; **OR**
- Switching to a different install method (LATCH or vehicle belt).

8

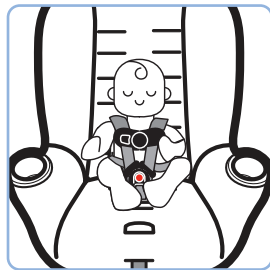

Secure Child in Car Seat

See pages 30-32.

continued on next page

9

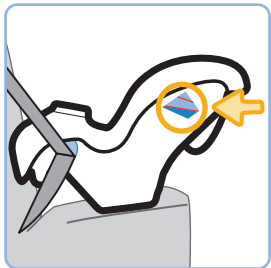

Recheck Rear-Facing Level Lines

Redo the installation if the car seat is not reclined correctly for your child.

See info box on this page.

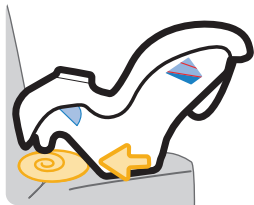

Only if necessary, you may place a tightly rolled towel(s) or foam pool noodle(s) under the front of the car seat to help get the correct recline angle for the **Rear-Facing Level Lines**.

Check often to make sure padding is still in place and the belt is tight.

FINISHED!



Lap/Shoulder Belt

Vehicle Belt Install: Is the vehicle belt locked? See step 5.

LATCH: Lower Anchor Belt Install: Are the hooks securely attached to the vehicle's lower anchors? See step 5.



Lap Belt

Is the belt tightened enough so that the car seat does not move more than 1 in (2.5 cm) from side to side? Check the tightness of the install often to make sure it has not loosened. See steps 6 and 7.



LATCH: Lower Anchor Belt

Is the **Rear-Facing Level Line** reclined correctly for your child? See steps 2, 9, and info box on page 17.



22-40 lb (10.1-18 kg) and 29-43 in. (73.6-110 cm) and at least 1 year old

Children **MUST** be at least 1 year of age to ride **Forward-Facing**.

In this car seat, your child can remain harnessed **Forward-Facing** until they outgrow any one of the following:

- **Weight Limit:** 40 lb (18 kg); **OR**
- **Height Limit:** 43 in. (110 cm); **OR**
- **Forward-Facing Child Fit** requirements, see page 21.

Before installing the car seat in your vehicle, check your child's fit in the car seat.

This way you won't have to redo the vehicle installation to make adjustments to the car seat.

Forward-Facing Child Fit: Page 21

Forward-Facing Vehicle Install: Page 23

WARNING:

You **MUST ALWAYS** attach, adjust, and secure the tether (top anchorage) strap when installing the car seat in the Forward-Facing Mode with internal harness.

DO NOT use the lower anchor belt along with the vehicle lap or lap/shoulder belt.

Check the vehicle belt or the lower anchor belt before each use.

Use **ONLY** if the belt can be tightened properly and locked securely in place.

DO NOT fasten multiple lower anchor hooks on the same lower anchor bar in the vehicle.

Even when unoccupied, this child restraint **MUST** be firmly secured to the vehicle with the lower anchor belt or with the vehicle seat belt.

In this child restraint your child **MUST** be at least 1 year old and weigh 22 lb (10 kg) before they sit forward-facing.

1

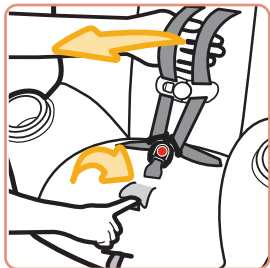

Fully Loosen Harness Straps

Push down on the harness release lever (through the opening in the pad) while pulling out on the harness straps as shown.

2

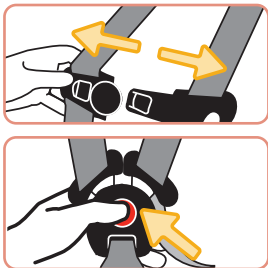

Undo Chest Clip & Buckle

It may be easier to undo the buckle by pressing in towards the top of the button.

3



Place Child in Car Seat

Your child's bottom and back should be flat against the car seat.

4



Head Position

The tops of your child's ears **MUST be below** the top of the car seat.

5

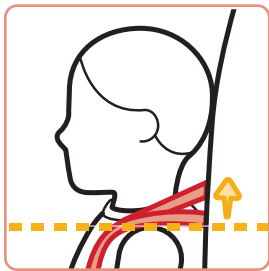

Harness Strap Position

The harness strap **MUST** be **at or slightly above** the shoulders; never below.

6

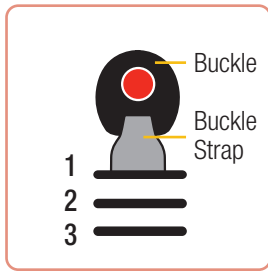

Buckle Position

- Use the slot closest to your child.
- The buckle **should not be underneath or behind** your child.

The buckle can be used in **any** buckle slot.

i

To change the harness strap height, see pages 33-35.

To change the buckle position, see page 36-38.

To learn how to check harness tightness, see pages 30-32.

If you cannot achieve a snug harness fit for your child, see pages 39-43.



Before installing the car seat in your vehicle, check to see if you need to adjust the buckle position or harness height for your child. **See page 21 for child fit.**

Once the car seat is installed, you will not be able to adjust the buckle position or the harness strap height.

Review Vehicle Owner's Manual

Determine what kind of vehicle belts your car has and how to use them to lock a car seat in place **OR** where LATCH: lower anchor seating positions are located in your vehicle.

There are 2 different methods for install.

Use only one:



Vehicle Belt

OR



LATCH: Lower Anchor Belt

WARNING:

DO NOT use both the LATCH: lower anchor belt and vehicle belt at the same time to install the car seat.

You **MUST ALWAYS** attach, adjust, and secure the tether (top anchorage) strap when installing the car seat in the Forward-Facing Mode with internal harness.

1

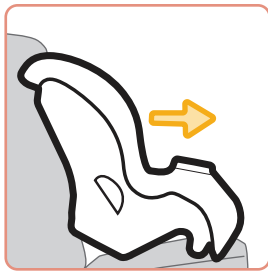

**Place Car Seat
Forward-Facing in
Back Seat**

The vehicle seat back **MUST** be upright.

i

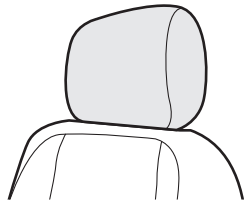

If your vehicle has a headrest that interferes with a flush car seat fit, check your vehicle owner's manual to see if it can be removed, adjusted, or if there are other possible seating locations for you to install.

continued on next page

2



Locate Vehicle Top Tether Anchors

Review your vehicle owner's manual for top tether anchor locations and how to route the tether strap when there are vehicle headrests.

3

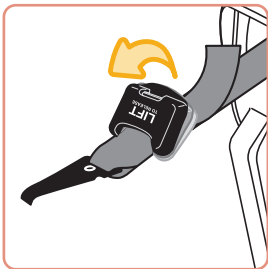

Lift Tether Adjuster to Loosen Tether Strap

4



Loosely Attach Tether Hook to Vehicle's Top Tether Anchor

5

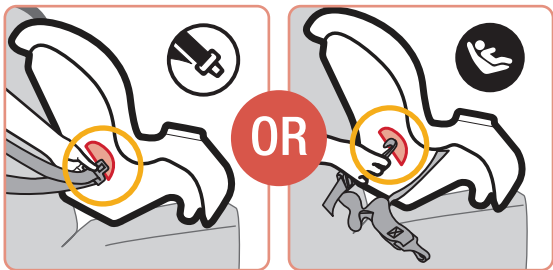

Locate **Forward-Facing Belt Path** & Route Vehicle Belt or Lower Anchor Belt Through It

For the LATCH belt: You may need to fully lengthen the belt before routing it into the belt path. Squeeze the adjuster button and pull the belt out as shown.



6

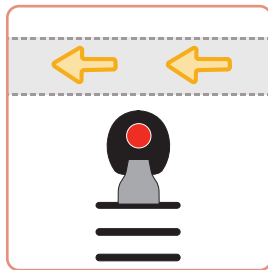

Vehicle Belt or Lower Anchor Belt Goes:

- under the car seat pad; **AND**
 - across the car seat; **AND**
 - out the other **Forward-Facing Belt Path** opening.
- DO NOT** twist the belt.

i

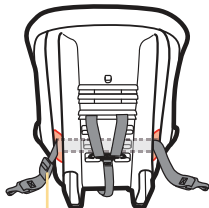

Adjuster

Finished Lower Anchor Belt Routing

The lower anchor belt adjuster can be on either side of the car seat.

continued on next page

7

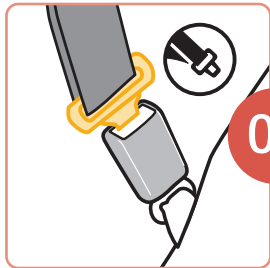

OR



Buckle Vehicle Belt

If your car has a **switchable retractor**, use it to lock the vehicle belt. Review page 55 of this manual or your vehicle owner's manual.

Attach Lower Anchor Belt Hooks to Vehicle's Lower Anchors

8

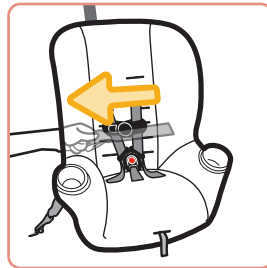
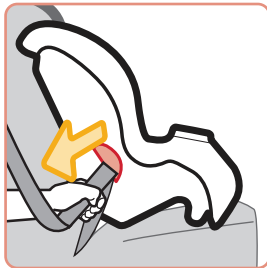

Tighten Belt

Place your hand in the car seat and firmly push the car seat down and back towards the vehicle seat. Pull the belt towards you and parallel (in line) with the belt path as shown.

For the LATCH belt or Lap Only Vehicle Belt: it may be easier to tighten if you route the free end of the belt back into the **Forward-Facing Belt Path**, reach into the **Forward-Facing Belt Path**, and pull the free end of the belt towards you.

9

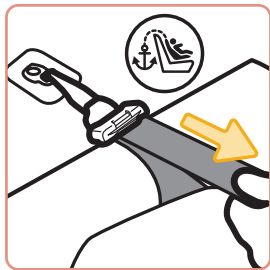

Tighten Tether

Push firmly on the back of the car seat and pull the free end of the tether strap to remove all of the slack.

10

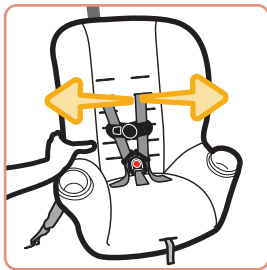

Check Belt Tightness

Hold the **Forward-Facing Belt Path** with your non-dominant hand. Push and pull from side to side.

The car seat should not move more than **1 in.** (2.5 cm).

i

If the car seat moves more than 1 in. (2.5 cm), you can try:

- Pulling the belt tighter; **OR**
- Reinstalling the car seat; **OR**
- Changing to a different seating location; **OR**
- Switching to a different install method (LATCH or vehicle belt).

continued on next page

FINISHED!



Lap/Shoulder Belt + Tether



Lap Belt + Tether



LATCH: Lower Anchor Belt + Tether



- Vehicle Belt Install:** Is the vehicle belt locked? See step 7.
- LATCH: Lower Anchor Belt Install:** Are the hooks securely attached to the vehicle's lower anchors? See step 7.
- Is the belt tightened enough so the car seat does not move more than 1 in (2.5 cm) from side to side? Check the tightness of the install often to make sure it has not loosened. See steps 8 and 10.
- Has the tether been installed and tightened? See steps 4 and 9.

Securing Child in Car Seat

1

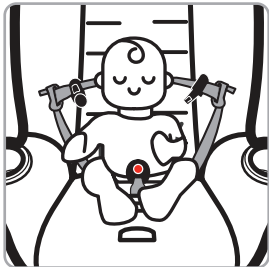

Place Child in Car Seat

Your child's bottom and back should be flat against the car seat.

2

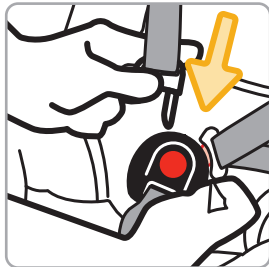

Buckle Harness

Pull the harness straps up to make sure the buckle is locked.

3

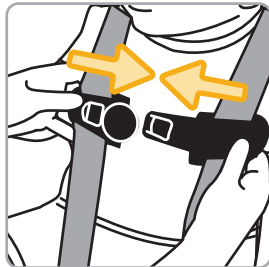

Fasten Chest Clip

Insert right half of the chest clip into the left half and snap together.

4

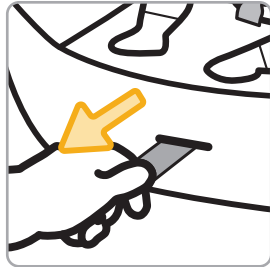

Tighten Harness

Pull the harness adjustment strap straight out to snugly tighten the harness.

continued on next page

5



Position Chest Clip

Slide the chest clip up the harness straps and position it at mid-chest (even with armpits) and away from your child's neck.

6

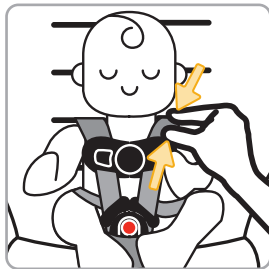

Check Harness Tightness

Unfasten the harness covers.

Try to pinch the harness at the shoulders vertically between index finger and thumb as shown.

If your fingers slip off, the harness is tight enough.

If you can pinch the harness strap, tighten more.

Fasten the harness covers.

i

A snug strap should not allow any slack.

It lies in a relatively straight line without sagging.

It does not press on the child's flesh or push the child's body into an unnatural position.

FINISHED!



Your child is now secured in the car seat. Check your child's fit often and make any needed adjustments to the car seat as they grow.

To Remove Child from Car Seat:

1. Loosen Harness Strap
2. Unbuckle Harness
3. Release Chest Clip
4. Remove Child

Troubleshooting

1. If the buckle or harness release lever sticks: DO NOT lubricate. Check for dropped food, sticky spilled drinks, dirt, leaves, etc.

Clean with warm water and/or remove the object with tweezers. If you cannot get the harness to adjust and remain tight with the buckle securely locked, **DO NOT** use this car seat.

2. If your harness twists:

Straighten the harness each time you put your child in the car seat. Lock the buckle and tighten the harness so it will be ready for next use.

⚠️ WARNING:

Failure to fasten and tighten the harness system correctly may allow the child to be ejected from the child restraint in a crash or sudden stop causing serious injury or death.

DO NOT mistake comfort for safety. The harness system must be snugly adjusted.



DO NOT put snowsuits or bulky garments on your child when placing them in the child restraint.

Bulky clothing can prevent the harness straps from being tightened properly.

! WARNING:

The harness system **MUST** be installed correctly. **DO NOT** use a child restraint with damaged harness straps.

1

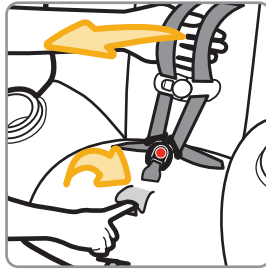

**Fully Loosen
Harness Straps**

Push down on the harness release lever (through the opening in the pad) while pulling out on the harness straps as shown.

2

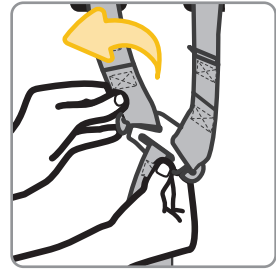

**From Back of Car
Seat, Remove
Harness Straps
Loops From
Splitter Plate**

3

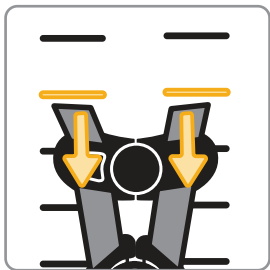

**Pull Harness Straps
Out of Shoulder
Harness Slots**

4

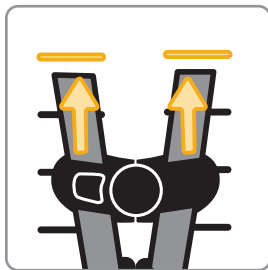

**Rethread Harness
Straps into Correct
Shoulder Harness Slots
For Your Child**

i

**For Rear-Facing Child
Fit**, see page 9.

**For Forward-Facing
Child Fit**, see page 21.

continued on next page

5

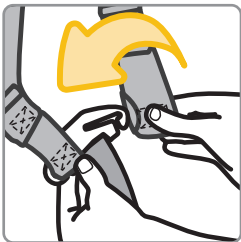

From Back of Car Seat, Attach 1st Harness Strap Loops to Splitter Plate As Shown

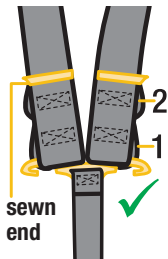

The sewn ends of the harness strap loops **MUST** face towards you.

DO NOT twist the harness strap or the harness adjustment strap.

Make sure the same harness strap loops are fitted completely on both sides of the splitter plate.

i

To learn how to check harness tightness, see pages 30-32.

If you cannot achieve a snug harness fit for your child, see pages 39-43.

Check the harness straps often for any wear or damage.

Changing Buckle Position

! WARNING:

Failure to place buckle's metal retainer completely through pad and child restraint can result in serious injury or death.

1

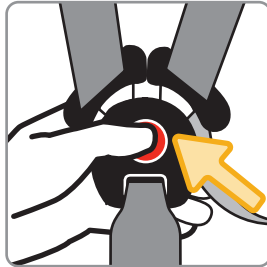

Unbuckle Harness

It may be easier to undo the buckle by pressing in towards the top of the button.

2



Turn Car Seat Over

Locate the buckle's metal retainer on the bottom of the car seat.

continued on next page

3

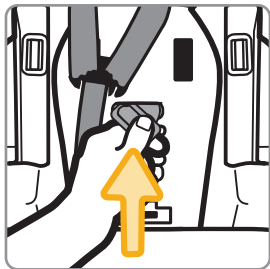

Rotate Metal Retainer & Push It Up Through Buckle Slot in Car Seat

4



From Top of Car Seat, Pull Buckle Out of Car Seat & Pad

5

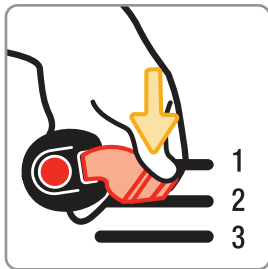

Insert Buckle's Metal Retainer into Slot Closest to Child

The buckle **MUST** face out.

i

For Rear-Facing Child Fit, see page 9.

For Forward-Facing Child Fit, see page 21.

6

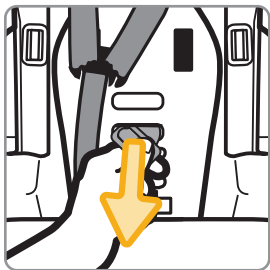

Pull Buckle's Metal Retainer Completely Through Pad & Car Seat

7



Check Buckle

Pull the buckle up to make sure it is secured.

The buckle **MUST NOT** pull out.

i

To learn how to check harness tightness, see pages 30-32.

If you cannot achieve a snug harness fit for your child, see pages 39-43.

i

If you cannot achieve a snug harness fit for your child, you may need to adjust the buckle strap and/or harness strap length as shown in this section.

WARNING:

The harness system **MUST BE** installed correctly. **DO NOT** use a child restraint with damaged harness straps.

Adjusting Buckle

1

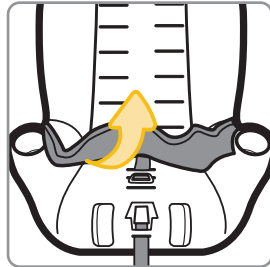

Pull Front of Car Seat Pad Up

2

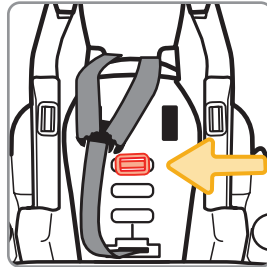

With Buckle in 1st Slot As Shown, Turn Car Seat Over

3

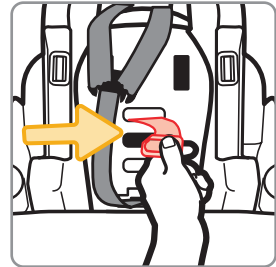

Pull Metal Retainer Towards You & Push It Up into Middle Slot As Shown

If you need to move the buckle to the 1st slot, see pages 36-38.

Adjusting Harness Straps

4

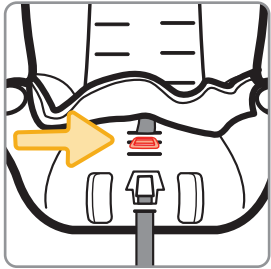

From Top of Car Seat,
Lay Metal Retainer
Flat Against Car Seat
As Shown

5

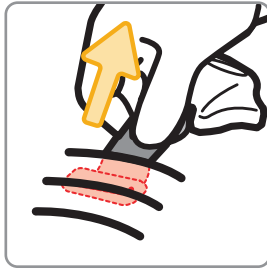

Replace Pad &
Check Buckle

Pull up on the buckle to make
sure it is secured.

The buckle **MUST NOT** pull out.

1

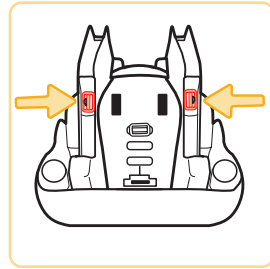

Turn Car Seat Over

Locate the harness straps'
metal retainers on the
bottom of the car seat.

continued on next page

2

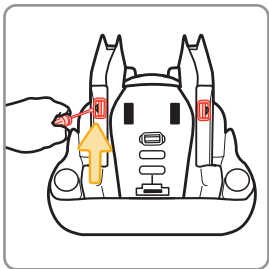

Remove Metal Retainers From Tabs

Using a flathead screwdriver, gently lift the metal retainer off of the tab.

Make sure the screwdriver does not touch the harness strap. Repeat for the other side.

3

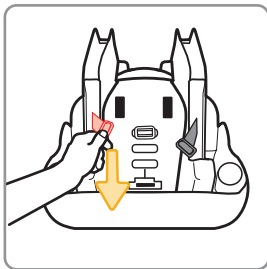

Pull Metal Retainer Towards You & Out of Its Original Location

Repeat for the other side.

4

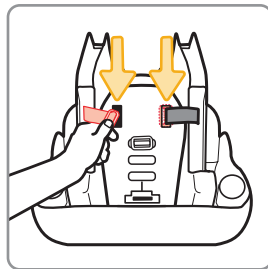

Push Metal Retainer Up into Slot on Bottom of Car Seat As Shown

Repeat for the other side.

From the top of the car seat, pull on the harness straps to make sure the retainers do not pull out.

5

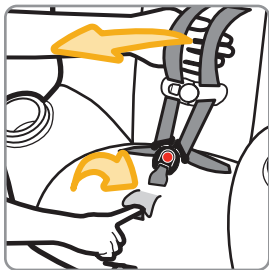

Fully Loosen Harness Straps

Push down on the harness release lever (through the opening in the pad) while pulling out on the harness straps as shown.

6

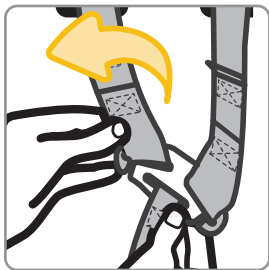

From Back of Car Seat, Remove Harness Strap Loops From Splitter Plate

7

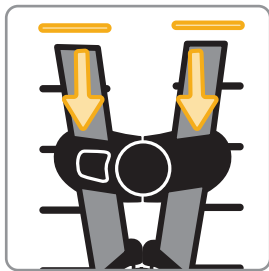

Pull Harness Straps Out of Shoulder Harness Slots

8

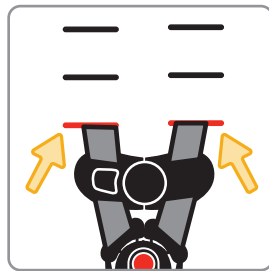

Rethread Harness Straps into Correct Shoulder Harness Slots For Your Child

continued on next page

i

For Rear-Facing Child Fit, see page 9.

For Forward-Facing Child Fit, see page 21.

9

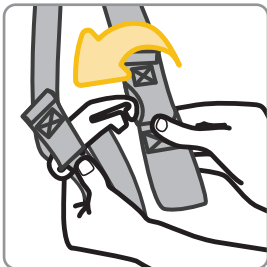

Attach 2nd Harness Strap Loops to Splitter Plate As Shown

i

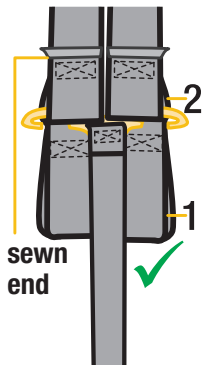

The sewn ends of the harness strap loops **MUST** face towards you.

DO NOT twist the harness strap or the harness adjustment strap.

Make sure the same harness strap loops are fitted completely on both sides of the splitter plate.

To return the harness strap to its original configuration:

1. Go to page 41 and reverse steps 2, 3, & 4.
2. Then go to page 33 and follow steps 2-5.

Removing Harness System & Seat Pad

i

Only remove the harness system to clean the seat pad

To remove accessories, see pages 3-4.

1

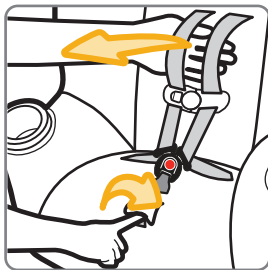

Fully Loosen Harness Straps

Push down on the harness release lever (through the opening in the pad) while pulling out on the harness straps as shown.

2

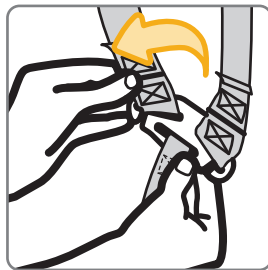

From Back of Car Seat, Remove Harness Straps Loops From Splitter Plate

3

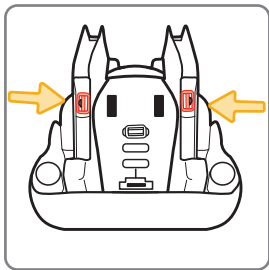

Turn Car Seat Over

Locate the harness straps' metal retainers on the bottom of the car seat.

4

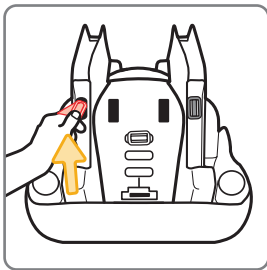

Remove Metal Retainers From Tabs

Using a flathead screwdriver, gently lift the metal retainer off of the tab.

Make sure the screwdriver does not touch the harness strap. Repeat for the other side.

5

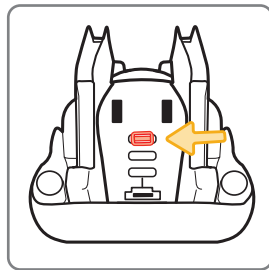

Locate Buckle's Metal Retainer

6

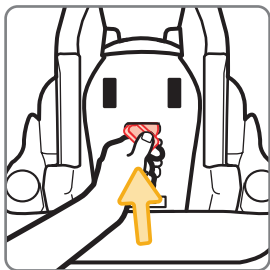

Rotate Metal Retainer & Push It Up Through Car Seat & Pad As Shown

7

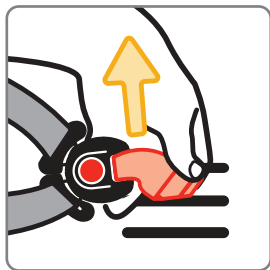

From Top of Car Seat, Pull Buckle Out of Car Seat

8

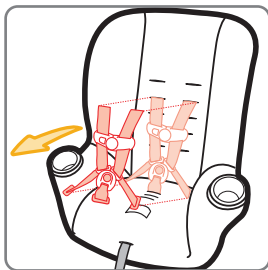

Pull Harness System Completely Out of Car Seat & Pad

9

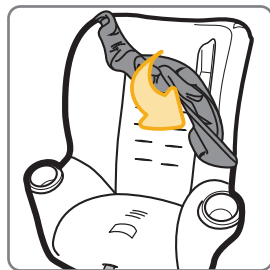

Remove Seat Pad
Pull the pad off the top of the car seat & remove it from the car seat.



You must remove the harness system and the accessories in order to remove the seat pad for cleaning.

To remove the harness system, see pages 44-46.

Cleaning Pad & Accessories

Machine wash separately with cold water on a gentle cycle. On select models: Make sure the harness covers are closed so the fastening strips are not exposed. **DO NOT** use bleach. Tumble dry separately for 10-12 minutes on low heat. Remove immediately.

Cleaning Harness Strap

Check the harness straps often for any wear or damage. Spot clean using warm sudsy water and damp cloth.

Spilled food and liquids on the car seat may result in mold or bacterial growth over time. These spills could also attract insects or rodents.

Cleaning Buckle & Car Seat

Spot clean using warm sudsy water and damp cloth.

DO NOT submerge into water.

WARNING:

DO NOT use the child restraint without the seat pad or with damaged harness straps.

Installing Seat Pad & Harness System

1



Starting from Bottom of Car Seat, Slip Pad on Car Seat

Pull the harness adjustment strap through the pad.

Wrap the pad around the top of the car seat.

2

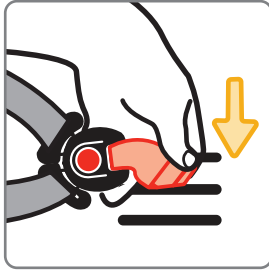

Insert Buckle's Metal Retainer into Slot Closest to Child

The buckle **MUST** face out.

3

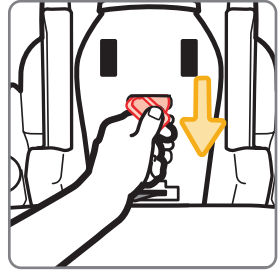

Pull Buckle's Metal Retainer Completely Through Pad & Car Seat

continued on next page

4

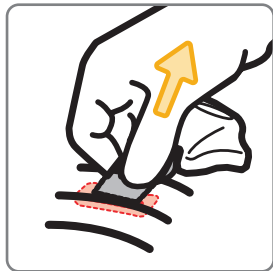

Check Buckle

Pull the buckle up to make sure it is secured.

The buckle **MUST NOT** pull out.

5

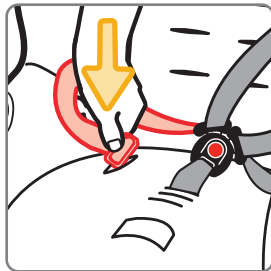

Push Harness Straps' Metal Retainers Down into Hip Harness Slots As Shown

Make sure the metal retainers go completely through the pad and car seat.

6

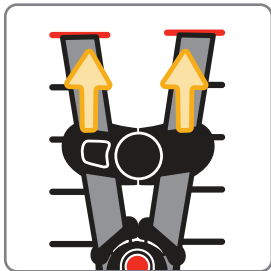

Thread Harness Straps Into Correct Shoulder Harness Slots For Your Child

i

For Rear-Facing Child Fit, see page 9.

For Forward-Facing Child Fit, see page 21.

7

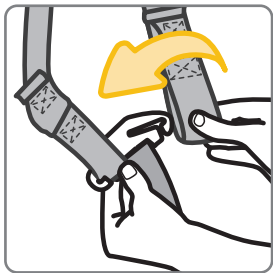

From Back of Car Seat, Attach 1st Harness Strap Loops to Splitter Plate As Shown

i

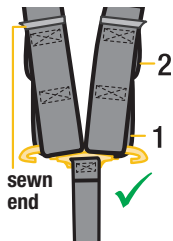

The sewn ends of the harness strap loops **MUST** face towards you.

DO NOT twist the harness strap or the harness adjustment strap.

Make sure the same harness strap loops are fitted completely on both sides of the splitter plate.



If the harness straps have been unthreaded from the buckle tongues and the chest clip, rethread them.

The harness strap end goes through the back of the buckle tongues and through the chest clip front to back as shown.

LATCH: Lower Anchor Belt

51

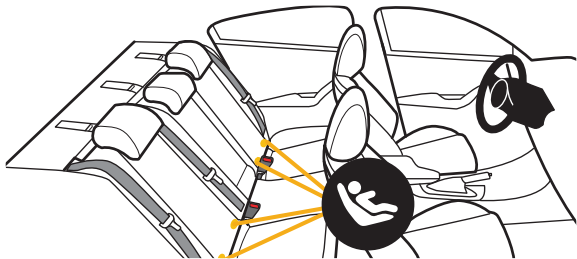

Your vehicle's features may be considerably different than those pictured here.

The lower anchors of **LATCH** (**L**ower **A**nchors and **T**ethers for **C**hildren) is a universal system for installing car seats without using vehicle seat belts. The LATCH: lower anchor belt can **ONLY** be used in vehicles that have the lower anchor bars installed in designated seating positions. Most vehicles manufactured after September 2002 are equipped with LATCH: lower anchor bars. Check your vehicle owner's manual to see which seating positions may be equipped with LATCH: lower anchor bars.

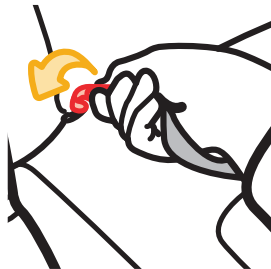

Lower Anchor Belt Storage Location

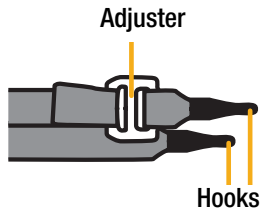

Lower Anchor Belt Parts

To Remove Lower Anchor Belt from Storage Location on Car Seat

Squeeze the spring lever on the hooks and remove the hooks from the attachments in the storage location.

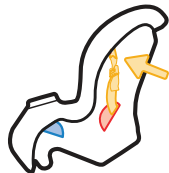
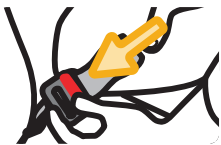

To Remove Lower Anchor Belt from Vehicle's Lower Anchor Bars

1. Remove the tension from the belt by pushing down on the side of the car seat with the adjuster.
2. Then press the adjuster's button to loosen the belt.
3. Squeeze the spring lever on the hooks, push the hooks back into the vehicle seat, and rotate the hooks to the side.
4. Pull the hooks out of the vehicle seat.

To Store Lower Anchor Belt

The lower anchor belt **MUST** be properly stored in its storage location when:

- using the vehicle belts to install the car seat; **OR**
- the car seat is not installed in a vehicle.

Thread the lower anchor belt through the Forward-Facing Belt Path.

Then attach hooks to the storage attachments as shown.

Gently pull the free end of the belt to remove slack.

WARNING:

DO NOT use both the lower anchor belt and vehicle belt at the same time.

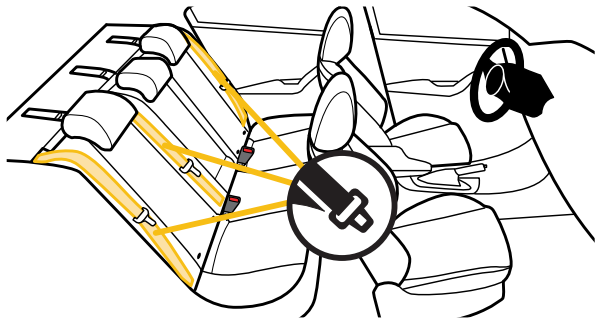

Your vehicle's features may be considerably different than those pictured here.

If LATCH: lower anchors are not an option, you must use the vehicle seat belt system to install the car seat.

Not all vehicle belts and seating positions will work with car seats. Please go through the following steps to understand how to lock a car seat in **Rear-Facing Mode or **Forward-Facing Mode** with a vehicle belt.**

1

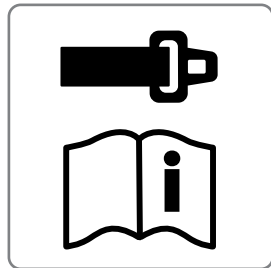

You MUST Review Your Vehicle Owner's Manual

Your vehicle owner's manual will let you know which vehicle belts and seating positions car seats can be installed in.

2



Check How This Car Seat Will Be Locked Into Place

The vehicle belt **MUST NOT** loosen after tightening.

This means there needs to be a way to lock the vehicle belt.

The ways this can be done are:

- By using the seat belt's retractor (see step 3); **OR**
- By using the seat belt's latch plate (see step 4).

3

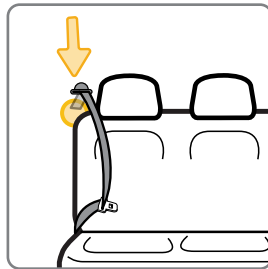

Check Retractor

Retractors pull seat belts into stored positions and lock the belt to hold passengers in place.

See the next page for some common types of vehicle belt retractors that will work with this car seat.

continued on next page

Types of Retractors



Switchable Retractor

(most vehicles have this type)

This retractor can be switched to a locking mode.

You **MUST have the retractor in the locking mode** to use the seat belt with this car seat.

Switching to locking mode: Slowly pull the shoulder belt all the way out, then let it go back in **1-2 in.** (2.5-5 cm).

As it goes back in, you will most likely hear a ratcheting sound.

Gently pull the belt to see if it has locked. You will not be able to pull any more belt out if the lock has engaged.

Automatic Locking Retractor

This retractor always locks.

It will automatically lock after slowly pulling the seat belt out at least halfway and letting the belt go back into the retractor **1-2 in.** (2.5-5 cm).

Emergency Locking Retractor

See Step 4

“Check Latch Plates”

If the retractor does not lock, it is most likely an Emergency Locking Retractor. These retractors only lock during a sudden stop or collision.

You will need to determine if your seat belt's latch plate can lock the belt. See step 4, “Check the Latch Plates”.

4

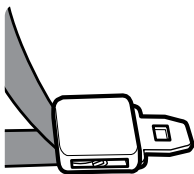

Locking
Latch Plate

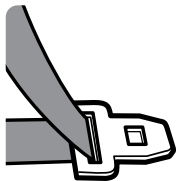

Emergency
Locking
Retractor with
a Sliding Latch
Plate

Check Latch Plates

Latch plates are the part of the seat belt that goes into the buckle.

To see if the latch plate locks:

1. Buckle Vehicle Belt
2. Firmly Tug Lap Portion of Seat Belt While Pulling It Up

If the vehicle belt does not slide through the latch plate, it's locked.

If the latch plate slides up and down the vehicle belt, it is a **sliding latch plate**.

Sliding latch plates easily slip between the lap and shoulder portions of the belt.

i

If you have an Emergency Locking Retractor with a Sliding Latch Plate, you must use a locking clip.

Please contact us for one, see the back cover of the manual or page 66.

Never Use the Following With This Car Seat:

- Emergency Locking Retractor Lap Only Belt
- Inflatable Seat Belts

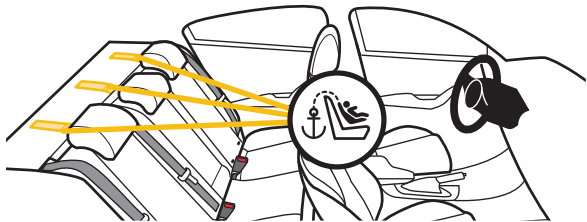

Your vehicle's features may be considerably different than those pictured here.

You **MUST** always attach, adjust, and secure the tether (top anchorage) strap when installing the car seat in the **Forward-Facing Mode** with internal harness. Tethers improve the installation and stability of car seats and reduce the risk of injury. Attach the tether hook to the tether anchor designated by your vehicle manufacturer for that seating position. Check your vehicle owner's manual for more information. If the seating position does not have a tether anchor, use a different seating position or see your dealer or a qualified mechanic and have one installed.

WARNING:

Using this child restraint without the tether strap anchored as required by the manufacturer would be a misuse of the child restraint and, in a sudden stop or crash, could result in serious injury or death.

DO NOT fasten multiple tether hooks on the same tether anchor in the vehicle.

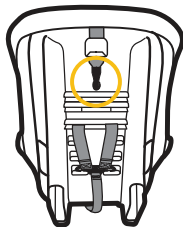

Storing Top Tether Strap

The tether strap **MUST** be properly stored in its storage location when:

- installing in **Rear-Facing Mode**; **OR**
- the car seat is not installed in a vehicle.

Attach the tether hook to its storage location as shown. Gently tighten to remove slack.

Child Restraint Use

WARNING:

NEVER take your child out of the child restraint while the vehicle is moving.

NEVER leave your child unattended. Placing your child in a hot child restraint may result in burns.

DO NOT use a child restraint with damaged or missing parts.

DO NOT use a child restraint with cut, frayed, or damaged harnesses.

DO NOT substitute parts or try to modify the child restraint in any way. **DO NOT** lubricate buckles and fasteners.

DO NOT use any child restraint accessory except those approved by Dorel Juvenile Group.

NEVER allow any child to play with this child restraint; it is not a toy.

DO NOT remove or cover up any of the warning labels or other labels on the child restraint.

This child restraint has been certified for use in passenger vehicles. **DO NOT** use in a boat, on a motorcycle or in a cargo van or bus where there are no seat belts or tether anchors.

Read all instructions for additional warnings.

WARNING:



NEVER place a child rear-facing in a seating position with an active frontal air bag.

Check the vehicle owner's manual for more information about air bag/child restraint use.



Use the child restraint only on vehicle seats that face forward.



DO NOT use on seats that face the sides or rear of the vehicle.

For vehicles without a back seat, refer to your vehicle owner's manual.



Children are safer when properly restrained in rear seating positions than in the front seating positions.

According to accident statistics, children in rear seating positions are statistically safer, whether you have air bags, advanced air bags, or no air bags at all.

If you are not sure where to place the car seat in your vehicle:

- Consult your vehicle owner's manual; **OR**
- Contact Dorel Juvenile Group Consumer Care Department; **OR**
- Visit your local Child Passenger Inspection Station. Go to <https://www.nhtsa.gov/equipment/car-seats-and-booster-seats> to find your closest station.

Installation in Vehicle

To avoid your child being seriously burned, take the following precautions:

- Park in the shade or where the sun does not directly hit the car seat.
- Cover the car seat with a sheet or blanket when not in use.
- Check for hot seat and buckles before placing child in car seat.

To help protect your vehicle seat's upholstery from damage: you may use an accessory approved by Dorel Juvenile Group or a single layer towel underneath and behind car seat.

WARNING:

Check the vehicle belt or lower anchor belt before each use. Use only if the belt can be tightened properly and locked securely in place.

Even when unoccupied, this child restraint **MUST** be firmly secured to the vehicle with the lower anchor belt or with the vehicle seat belt.

In a crash or sudden stop, an unsecured child restraint could injure occupants.

DO NOT risk your child's safety.

To keep your child as safe as possible, Dorel Juvenile Group strongly recommends replacing the car seat even after a minor crash; even if it was not occupied at the time.

Replacement After a Minor Crash

The National Highway Traffic Safety Administration states that for a crash to be considered minor **ALL of the following MUST be true:**

- Vehicle able to drive away from the crash site; **AND**
- Vehicle door nearest the car seat was not damaged; **AND**
- No passengers were injured; **AND**
- Airbags did not deploy; **AND**
- There is no visible damage to the car seat.

If the crash your car seat was involved in meets **ALL** the

criteria, you may not need to replace the car seat. If one or more of these criteria are not true or if you are uncertain of any of your answers, replace the car seat immediately.

Replacement After a Moderate to Severe Crash

You **MUST** replace this car seat if it has been in a moderate to severe car crash.

This car seat is intended to protect a child in a single crash. During a crash, the car seat and all of its parts absorb crash energy which can deform or weaken it. Damage is not always visible. A damaged car seat **MUST** be replaced immediately.



Expiration

On the side of the car seat there is a date of manufacture label as shown.

DO NOT use this car seat more than 8 years after the date of manufacture.

Registration & Safety Notices

Please complete the postage-paid registration card that came with your child restraint, and send it to us.

Child restraints could be recalled for safety reasons.

You must register this restraint to be reached in a recall.

Send your name, address, e-mail address if available and the restraint's model number and manufacturing date to:

Dorel Juvenile Group

2525 State Street
Columbus, IN 47201

or call 1-800-544-1108 or register online at
<https://www.coscokids.com/registration>.

For recall information, call the U.S. Government's Vehicle Safety Hotline at 1-888-327-4236 (TTY: 1-800-424-9153), or go to www.NHTSA.gov.

0515079	Tear Off and Mail This Part or Register Online		4348-0081D
Consumer: Just fill in your name, address and email. Please print (use dark ink).			
Your Name			
Your Street Address			
City		State	Zip Code
Email Address (optional)			
Model Number	Model Name	Manufacture Date	
AB123CDE	Safety 1st Car Seat	05/16/2015	
L#11 B265035			

Example of model number, manufacture date, and line code.



If you don't have the card or if your address changes, you will find the model number, manufacture date, and line code on the label located on the side of the car seat.

This restraint is certified for aircraft use.



Rear-Facing Aircraft Installation

Follow the steps on pages 11-17.



Forward-Facing Aircraft Installation

Follow the steps on pages 23-28, skipping the tether strap steps.

Install the car seat in a window seat to avoid blocking the aisle. If the aircraft lap belt is too short, ask the flight attendant for a belt extender.

Use only on forward-facing aircraft seats. Contact the airline for their specific policies.



Some airlines may ask to see a label stating that this car seat is certified for aircraft use.

There is an airplane certification label located on the side of this car seat as shown.

WARNING:

You **MUST** store the lower anchor belt and tether strap when installing with aircraft belts.

Warranty

Dorel Juvenile Group, Inc. (DJG) warrants this product to the original retail purchaser as follows: This product is warranted against defective materials or workmanship for one year from the date of original purchase.

An original receipt is required to validate your warranty.

DJG will, at its option, provide replacement parts or replace this product. DJG reserves the right to substitute if the part or model has been discontinued.

To make a claim under this warranty, please contact our Consumer Care Department by phone: 1-800-544-1108 or text: 1-812-652-2525.

Our hours of operation are from 8:00 a.m. to 6:00 p.m. EST Monday through Thursday and from 8:00 a.m. to 4:30 p.m. on Friday.

Proof of purchase is required and shipping charges are the responsibility of the consumer.

Warranty Limitations: This warranty does not include damages which arise from misuse or abuse of this product.

Limitation of Damages: The warranty and remedies as set forth are exclusive and in lieu of all others, oral or written, expressed or implied. In no event will DJG or the dealer selling this product be liable to you for any damages, including incidental or consequential damages, arising out of the use or inability to use this product.

Limitation of warranties and other warranty

terms and state law rights: Any implied warranties, including implied warranties of the merchantability and fitness for a particular purpose, shall be limited to the duration and terms of the express written warranty.

Some states do not allow limitations as to how long an implied warranty lasts or the exclusion or limitation of incidental or consequential damages, so the above limitations may not apply to you.

This warranty gives you specific legal rights, and you may have other rights, which vary from state to state. Neither DJG nor the dealer selling this product authorized any person to create for it any other warranty, obligation, or liability in connection with this product.

Replacement Parts List

(on select models)

- Buckle Assembly
- Chest Clip
- Harness Straps
- Seat Pad Set
- Lower Anchor Belt
- Top Tether
- Locking Clip
- Instructions

For parts availability and questions, call, text, or chat.

If requested color is not available, similar color will be substituted.

Applicable tax and shipping & handling will also be added.



Send Us a Text:

1-812-652-2525

(US and Canada Only
Carrier Fees May Apply)



Find Us Online:

www.coscokids.com

Email Us:

support@djgusa.com



Give Us a Call:

1-800-544-1108

(Toll Free
US and Canada Only)

COSCO[®]

SIMPLE

SMART

FUN



Send Us a Text: 1-812-652-2525
(US and Canada Only. Carrier Fees May Apply)



Find Us Online: www.coscokids.com

Email Us: support@djgusa.com



Give Us a Call: 1-800-544-1108
(Toll Free, US and Canada Only)